



Fence Catalogue 2016/2017





Electric Fence Units	04 - 17	Litzclip®	52 - 53
230 V Mains Energizers	04 - 06	Connectors for Tape, Rope and Polywire	54 - 55
DUO Devices	07	Reels	56 - 57
12 volt battery-operated device	08 - 09	Insulators	58 - 68
Solar Panels	10	Ring Insulators	58 - 59
Metal Battery Boxes	11	Rope Insulators/Wire Insulators	60
9 V Battery Energizers	12 - 14	Tape Insulators	61 - 62
Farm Patrol - Energizers	15 - 17	Corner Insulators	63 - 65
Fencing- and Safety Products	18 - 19	Insulators with metric thread	66
Hobby Energizer-Sets	20	Offset Insulators	67
Grounding and Fence Equipment	21	Supplementary Insulators	68
Batteries	22 - 23	Permanent Fencing	51, 69 - 71
Connection and Grounding Accessories	24 - 25	Gate Systems	72 - 74
Posts	26 - 38	Gate handles	75 - 77
Wooden Posts	26	Pasture Gates	78 - 80
T-Post System	27 - 30	Panels and Feeding Places	81 - 85
Plastic Posts and Glass Posts	31 - 35	Netting	86 - 96
Recycling Posts and Metal Posts	36 - 38		
Fencing Accessories	39		
Conductors and Accessories	40 - 51		
Star	40 - 41		
Profi	42 - 43		
Classic	44 - 45		
Basic	46 - 47		
Polywires and Wires	48 - 49		
Horse Wire	50		

These symbols explain our pack units!



1 / 4 / 16

The first figure (1) shows you the unit of sale (number or sale-promoting package). It is the price basis. The following figures (4, 16) show you other possible packaging units.



6

Pieces in self-service-pack

Sales promotion packaging! The number quoted is the number contained in the pack. Here the price refers to the packaging units.



25

Pieces per bag



5

Pieces per bunch



90

Pieces per bucket

MA

3

The number indicated here tells you the total number of pieces per master package.



10

The number indicated here tells you the total number of pieces per master package.



200

The number indicated here tells you the total number of pieces per pallet.

€









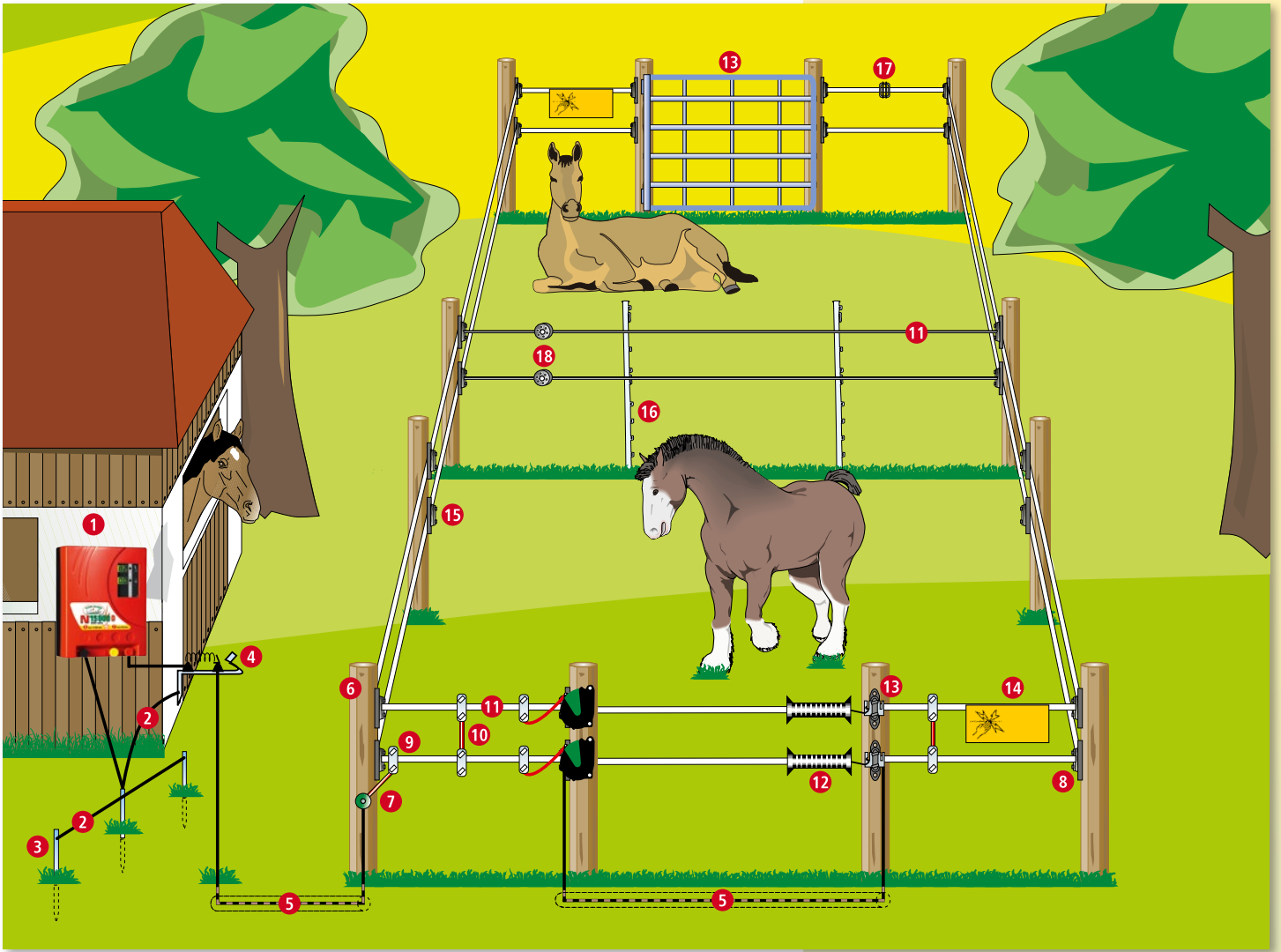

All prices provided are the manufacturer's recommended retail prices and are inclusive of VAT. The price quoted in the catalogue applies to one unit or one sales-promoting pack.

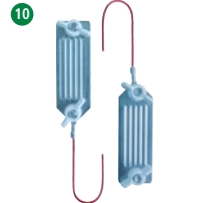

All items marked with this icon must be shipped by freight carrier due to the nature of their scale/size or weight. This creates separate freight costs! Optimise freight costs by ordering entire pallet units!

Electric Fencing - How it's done!



 <p>1 Energizer for Mains- or Battery Operation (p. 04-17)</p>	 <p>2 Earthing Cable (p. 21)</p>	 <p>3 Ground Rod (p. 21)</p>	 <p>4 Lightning Protection (p. 39)</p>	 <p>5 Underground Cable, high-voltage resistant (p. 21)</p>	 <p>6 Permanent Fencing Posts (p. 26-30)</p>
 <p>7 Cut-Out Switch (p. 39)</p>	 <p>8 Corner Insulator (p. 63-65)</p>	 <p>9 Fence Connecting Cable (p. 24-25)</p>	 <p>10 Tape Connecting Cable (p. 24-25)</p>	 <p>11 Tape, Rope, Polywire or Wire (p. 40-50)</p>	 <p>12 Gate Handle Systems (p. 75-77)</p>
 <p>13 Gate Components (p. 78-80)</p>	 <p>14 Warning Sign (p. 39)</p>	 <p>15 Line Insulator (p. 58-62, 66-68)</p>	 <p>16 Portable Fencing Post made of plastic or metal (p. 31-38)</p>	 <p>17 Special Connector (p. 52-55)</p>	 <p>18 Wire/Tape Strainer (p. 70)</p>

Explanation of symbols

Symbols	Description	Unit	Explanation
	Grounding	Piece	In order to enable electricity to flow freely from the ground to the device, optimal contact should be ensured between the earthing rod and soil (dry soil is a poor electricity conductor). The earthing rod (which must be galvanised) should therefore be driven into a damp area, or the length of the earthing rod should be measured to ensure that deeper, damper soil layers are reached. The recommended number of earthing rods depends on the power class of the device.
	Resistance	Ohms	The following resistance can be identified in a fence system: Earthing resistance => should be as low as possible Conductive material resistance => displayed in Ohm/metres. The smaller this value, the better the material's conductivity. The conductivity requirements of the material used increase with the length of the fence. The best materials have a resistance smaller than 0.25 Ω/m. Isolator resistance => should be as high as possible
	Max. Voltage	Volts	This voltage is reached with a low fence charge.
	Voltage in Open Circuit	Volts	Voltage when no fence system is connected to the electric fencer device.
	Voltage at 500 Ohms	Volts	Voltage at a fence charge of 500 Ohm.
	Stored Energy	Joules	Energy absorbed by device. The electric fencer efficiency ratio yields the relevant discharge energy value for the user.
	Max. Output	Joules	Maximum energy transmitted from the device to the fence system. This pulse is also identified as shock strength.
	Output Energy	Joules	Minimum energy transmitted from the device to the fence system. This can be reached through a fence output with reduced power or through selecting the lowest power level of an electric fencer device.
	Theor. Fence Length VDE (2000 V)	km	With fence lengths in accordance with VDE, only a theoretical value is given, which, as a result of various influences (fence flora, weather and soil conditions) cannot be reached in practice.
	Max. Fence Length with Varying Vegetative Growth	km	Flora on the fence has a considerable influence on the max. fence length for an electric fence device. The more vegetation on the fence, the higher the fence charge will be, thus reducing the max. fence length. The fence length indications refer to highly conductive wire material and connectors, good isolators and an optimal earthing system!
	Approx. Number of Electrifiable Nets	Piece	For 230 V and 12 V devices, the maximum number of 50 m lines to be used is given.
	Voltage Supply 230 V	Volts	Devices with power supplies (230 V) have an unlimited protection duration. These are available in all necessary power classes and are the best solution for power provision to long fences. Even in the event of heavy vegetation, sufficient energy is supplied to the fence.
	Voltage Supply 12 V or 12 V Solar	Volts	12 Volt battery chargers are the ideal solution for long fences or fences with considerable amounts of vegetation in the event that no power supply is available. The discharge energy can be compared to the power supply units. Rechargeable 12 Volt wet cells are used as a source of power. A useful addition are solar modules, which are offered in a range of power classes and transform solar energy into electricity.
	Voltage Supply 230 V or 12 V	Volts	This type of device combines the unlimited protection duration of the 230 Volt devices with the mobility of the powerful 12 Volt devices.
	Voltage Supply 9 V	Volts	The 9 Volt dry battery devices are characterised by their excellent mobility, coupled with a long battery life. They are ideal for short fences with moderate vegetation if no power supply is available.
	Voltage Supply 2 x 1.5 V	Volts	3 Volt devices are mobile and easy to handle, and are suitable for fences without vegetation, such as in gardens or horse-training paddocks.
	Power Consumption	mA	The duration of an electric fencer device can be calculated from the power consumption along with battery or accumulator capacity.

This is how an electric fence system works!

The electric fence system: It's a circuit

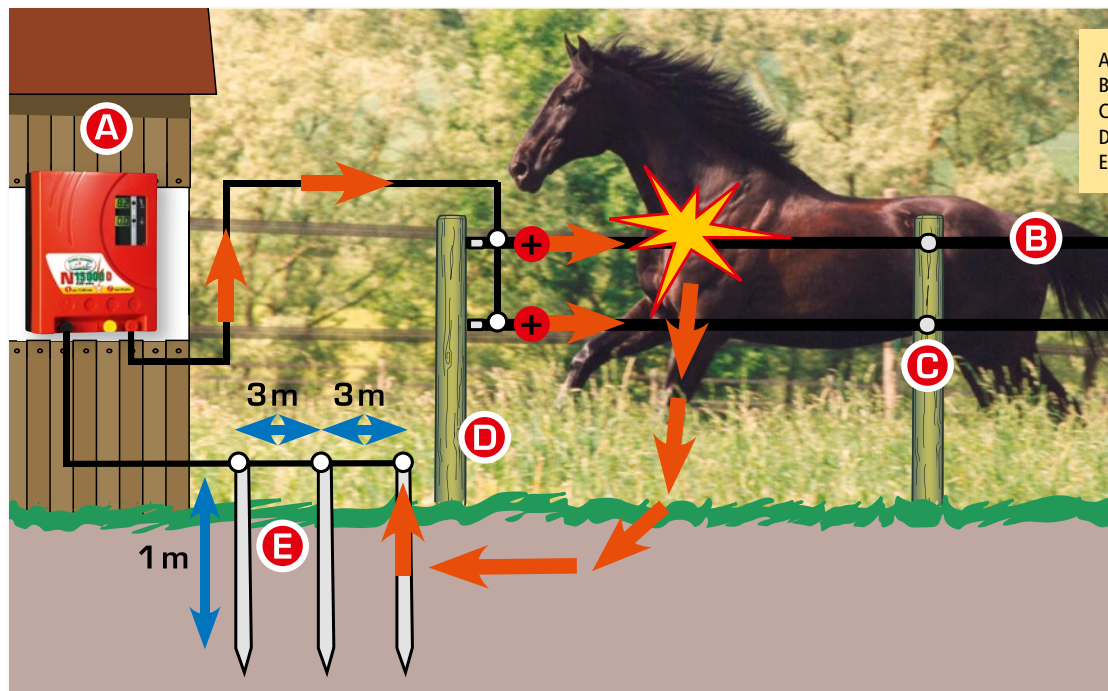

- A) Electric Fencer
- B) Conductors
- C) Insulators
- D) Posts
- E) Ground Rods

This is how an electric fence system works:

When an animal touches the conductor (tape, polywire or rope) the electric circuit closes and a shock is delivered to the animal. This is completely harmless for the animal, but in future the animal will respect the electric fence.

Electric Fencer:

By giving off intermittent pulses the fence unit is the heart of the electric fencing system. It is decisive to choose the right fencer by considering the voltage on resistance. In general a resistance of 500 Ohms is taken as basis, because this is the resistance on the fence during animal contact. According to VDE standards the voltage must not be below 2,500 volts, as otherwise the functioning of the electric fence system will be reduced (for thick-coated animals we recommend a minimum voltage of 4,000 volts).

The new mains-powered and battery devices by EURO-GUARD therefore include a visual warning signal, which is activated when voltage falls below 2,500 volts, ensuring optimum protection and safety. In contrast, the often-specified open circuit voltage only has a minor influence. Another important consideration in selecting a device is what is known as pulse energy, which indicates the actual output power as opposed to the charging energy (energy in the device).

For precise technical details of our Euro Guard fence units please consult the tables on pages 3 to 10. Among others these tables recommend the fence lengths for each unit. Please note that the fence length indicated according to VDE standards is only a theoretical value, which in practice is never accomplished due to various factors (e.g. vegetation growth on fence).

In case mains is available nearby, always choose a mains energizer because a permanent power supply guarantees perfect tending safety. If there is no power connection, for longer fences and you want to contain animals hard to tend or to repel (e.g. wild boars), we recommend the use of a 12-Volt rechargeable battery or a solar panel powered fence unit. For shorter fence lines and easy-to-tend animals, however, a 9 V battery powered unit is sufficient.

Conductors:

Conductors (stainless steel or copper wires) transport electric current! The conductors available are: Tapes, ropes, polywires and wires. Furthermore you can choose between three different quality levels: Star, Profi, Classic and Basic.

Insulators:

Please always make sure that all insulators are in perfect condition. Weather-related abrasion and chafe marks reduce the insulation. In case of discharges there is no more tending safety. Therefore always check the mounted insulators for perfect functioning and have all damaged insulators replaced. Always make sure to use the right insulators for each purpose.

Grounding:

Highly important but in practice often badly neglected. When an animal touches the conductor the circuit closes – but only if the current going through the animal into the ground returns to the unit. Please note that for all the various units there has to be a special grounding. For mains and rechargeable battery units two to three ground rods have to be used. In addition the consistency of the soil plays an important part on choosing the right kind and amount of ground rods. There is a higher resistance in dry soils than in moist ones and therefore there has to be a stronger grounding.

230 Volts Mains Energizers

The new Euro Guard generation of fencing units with extremely high output energy 5 - 15 Joules!

- the delayed power adjustment makes touching the fence safer for people and animals
- the fence is constantly monitored by an alarm function, which triggers an alarm and slows the pulse sequence if the fence is touched for an extended period of time
- very low power consumption in normal operating mode, making it very eco- and climate-friendly
- much safer and more energy efficient in comparison to conventional devices, thanks to Euro Guard pulse technology, and more secure for animals even when vegetation is thick thanks to the extremely high fence voltage
- with two fence outputs (high/low)
- microprocessor controlled
- Made in Germany



Fitted with two fence output terminals (max/min)

Extremely effective power supply units designed for very robust animals, vegetation and very long fences. Together, all the digital EuroGuard displays enable constant, detailed monitoring of the whole fencing system.

The use of cutting-edge SMD technology and the latest micro controllers ensures the highest levels of reliability and performance.



Monitoring: Fence output voltage
Fence output voltage display in kilovolts. This enables identification of even the smallest changes in the fence's condition.

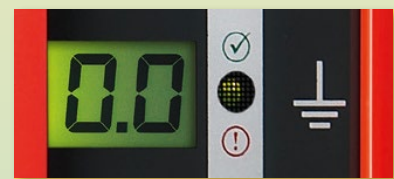

Monitoring: Earth voltage
Earth voltage display in kilovolts. The lower the displayed value, the better the device's earth connection.



The new EuroGuard-N/ND series complies with the safety standard for electric fences that came into effect on 01/09/2010. According to this standard, the output energy is limited to a maximum of 15 joules. Devices ranging from 5 to 15 joules must be equipped with a power adjustment delay for altered loads and must feature an alarm function. The time delay ensures that there is sufficient time in which to retreat safely from the fence.



However, if there is contact with the fence for a long period of time, the pulse sequence is slowed significantly and an audio-visual alarm is triggered.



Bi-colour flashing LED lights support the corresponding LCD display value.
Green flashing = displayed value is acceptable
Red flashing = the value does not meet minimum requirements. Please fix faults!

230 Volts Mains Energizers



Euro Guard N 8000

manufactured in accordance with the new European safety standard EN60335

- highly efficient power supply unit with intelligent power adjustment=> Euro Guard pulse technology
- designed for robust animal species such as cows, sheep, horses and for deterring wild animals; for long fences with heavy vegetative growth
- three flashing LEDs for output voltage, earth potential and power consumption
- power consumption 7.0 watts/hour



ref. no.		€
392080	1	

Euro Guard N 10000 D, Digital

manufactured in accordance with the new European safety standard EN60335

- extremely high-capacity power supply unit with intelligent power adjustment=> Euro Guard pulse technology
- designed for robust animal species such as cattle, sheep, horses and for deterring wild animals; for very long fences with heavier vegetative growth
- two illuminated digital displays for output voltage and earth potential, plus additional two-coloured flashing LEDs
- power consumption 13.0 watts/hour



ref. no.		€
392111	1	

Euro Guard N 15000 D, Digital

manufactured in accordance with the new European safety standard EN60335

- ultra high-capacity power supply with intelligent power adjustment that uses the maximum permissible limit values => Euro Guard pulse technology
- highest-capacity Euro Guard power supply unit for extremely long fences, heavy vegetation and very robust animals
- two illuminated digital displays for output voltage and earth potential, plus additional two-coloured flashing LEDs
- power consumption 18.0 watts/hour



ref. no.		€
392115	1	



type	ref. no.											
N 8000	392080	11,000 V	7,600 V	8.00 J	6.00 J	0.55 J	180.0 km	60.0 km	12.0 km	6.0 km	20	3
N 10000 D	392111	11,000 V	8,200 V	13.00 J	9.00 J	0.55 J	280.0 km	75.0 km	16.0 km	7.5 km	25	5
N 15000 D	392115	11,500 V	8,500 V	20.00 J	14.50 J	0.60 J	330.0 km	90.0 km	20.0 km	10.0 km	30	5

230 Volts Mains Energizers



Euro Guard N 1400

Efficient mains energizer for smaller fence systems or paddocks offers reliable high performance use and is unaffected by vegetative growth on short runs of fence.

- 3 years guarantee
- break-proof plastic
- visual operation control
- ideal for smaller fence systems
- splash-proof
- interference-free
- power consumption 5.0 watts/hour

ref. no.		€
44138	1	



Euro Guard N 2000

- efficient power supply unit; manufactured in accordance with the new European safety standard EN60335
- can be used with light vegetative growth
- for universal use with standard fences; for horses, cows, dogs, cats
- fitted with two fence outputs (high/low)
- visual fence voltage display and separate visual earthing display (a flashing red light indicates a fault)
- microprocessor controlled
- power consumption 3.8 watts/hour
- Made in Germany

ref. no.		€
392020	1	



Euro Guard N 5500

- highly efficient power supply unit; manufactured in accordance with the new European safety standard EN60335
- our all-round product can be used with medium to heavy vegetative growth; for horses, cattle, sheep, goats and for deterring wild animals
- fitted with two fence outputs (high/low)
- visual fence voltage display and separate visual earthing display (a flashing red light indicates a fault)
- microprocessor controlled
- power consumption 6.0 watts/hour
- Made in Germany

ref. no.		€
392055	1	



type	ref. no.											
N 1400	44138	10,000 V	4,500 V	1.50 J	1.00 J	-	30.0 km	10.0 km	2.0 km	0.8 km	2	1
N 2000	392020	9,000 V	4,800 V	2.80 J	2.00 J	0.50 J	60.0 km	15.0 km	3.0 km	1.5 km	4	2
N 5500	392055	10,000 V	5,700 V	5.50 J	3.60 J	0.55 J	90.0 km	28.0 km	4.5 km	2.0 km	15	3

12 V / 230 V - DUO Units



Euro Guard DUO Electrical Fence Units 2 in 1

Two power input options available - 230 V mains supply or 12 V battery units.

That means, the unit can be used for permanent fencing with 230 V mains supply and also for mobile fencing with 12 V primary or rechargeable batteries. As a standard, the devices are delivered with a 12 V supply cable (incl. stainless steel clamps), with 230 V mains adapter and with fence and earth connecting leads. Casing is splash water resistant and allows an outdoor installation without any problems. When the unit is operated with 230 V the mains adapter should be installed indoors.

- latest electric fencing technology - microprozessor controlled
- optimized consumption thanks to energy saving mode
- full discharge protection with 12 V operation
- Made in Germany
- 3 years guarantee

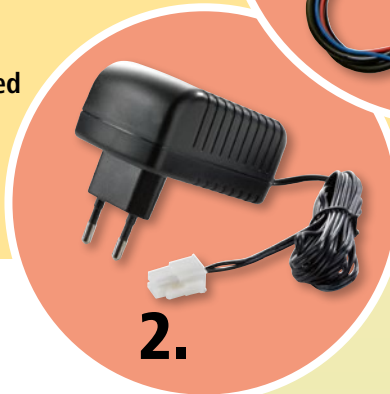

Euro Guard DUO NA 1200

DUO unit for smaller fence systems with low vegetation. Ideal for horses, cows and small animals.

- latest electric fencing technology - microprozessor controlled
- optimized consumption thanks to energy saving mode
- full discharge protection with 12 V operation
- 2 power levels (high/low)
- allows for solar assistance
- Made in Germany
- 3 years guarantee



ref. no.		€
392042	1	



Euro Guard DUO NA 2300

DUO units for normal fence systems also with vegetation. For horses, cows and sheep.

- latest electric fencing technology - microprozessor controlled
- optimized consumption thanks to energy saving mode
- full discharge protection with 12 V operation
- 2 power levels (high/low)
- Made in Germany
- 3 years guarantee



ref. no.		€
392043	1	



type	ref. no.											
DUO NA 1200	392042	9,900 V	4,300 V	1.70 J	1.20 J	28-126 mA	40.0 km	8.0 km	2.5 km	1.0 km	3	2
DUO NA 2300	392043	12,000 V	4,900 V	3.20 J	2.30 J	42-300 mA	60.0 km	20.0 km	5.0 km	2.0 km	7	2

12 Volts - Rechargeable Battery Energizers



Euro Guard

Very powerful 12 volts rechargeable battery unit for portable use on long fence runs and sturdy breeds.

- large battery housing (up to 85 Ah battery)
- with 12 Volt full discharge protection
- impact strength continuously adjustable
- allows for alternative operation with a 9 Volt alkaline, dry battery (max. approx. 0.5 J)
- solar operation possible
- two separate LEDs for fence condition and battery condition control
- can also be operated as a 230 volt mains device with a mains adapter (item no. 371012; not included)



ref. no.		€
392260	1	



Euro Guard S 4600 Digital

Very powerful 12 volts rechargeable battery unit. Reliable high performance use also under extreme conditions. Recommended for sheep containment and to keep off predators. With digital display for output, power stages and battery voltage reading.

- large battery housing (up to 12 V/85 Ah battery)
- featuring 12 volts full discharge protection
- steplessly variable output energy
- can also be operated as a 230 volt mains device with a mains adapter (item no. 371012)
- two separate LEDs for fence condition and battery
- allows for alternative operation with a 9 Volt alkaline, dry battery (max. approx. 0.5 J)
- allows for solar assistance - build in solar charge-controller



ref. no.		€
392461	1	



Digital



Also useable for deterring wild animals

Mains Adapter

- connects to 230 Volt power supply (allows for fencer operation with or without 12 Volt rechargeable battery). Do not use as battery charger

ref. no.		€
371012	1/60	



type	ref. no.											
S 2600	392260	10,500 V	4,500 V	2.60 J	1.50 J	15-150 mA	40.0 km	15.0 km	6.0 km	2.5 km	6	3
S 4600	392461	10,500 V	6,000 V	5.20 J	3.00 J	17-290 mA	80.0 km	30.0 km	10.0 km	4.0 km	12	3

12 Volts - Rechargeable Battery Energizers



Euro Guard A 1000

- 3 years warranty
- effective 12 volt electrical fencing unit for portable applications
- ideal for horse fencing as well
- with function monitoring display
- equipped with deep discharge protection
- with battery condition control (red LED flashes, when battery reaches about 40 % of its remaining capacity)
- weather-resistant, robust housing

ref. no.		€
392010	1	



Euro Guard A 4000

- 2 power levels
- extreme powerful 12 Volt rechargeable battery unit for the toughest jobs - also for fence lines with heavy vegetative growth. Runs also on very large 12 Volt rechargeable batteries without any problems
- low power consumption thanks to energy saving mode
- with 12 Volt full discharge protection
- with optical fence condition control
- with battery condition control (red LED flashes, when battery reaches about 40 % of its remaining capacity)
- with On/Off-switch
- 12 V battery terminals made from very high-quality stainless steel
- allows for solar assistance – in addition connects through mains adapter (item no. 371012) to 230 Volt mains supply

ref. no.		€
392040	1	

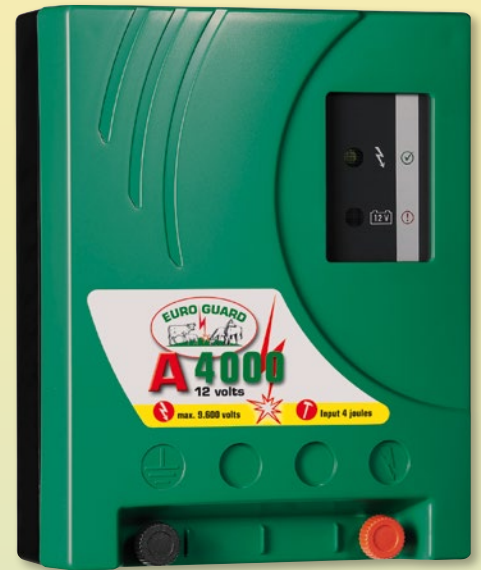

Euro Guard A 10000

- 2 power levels
- our most powerful 12 Volt rechargeable battery unit for the toughest jobs, for long fence lines or fences with heavy vegetative growth. Runs also on very large 12 Volt rechargeable batteries without any problems
- low power consumption thanks to energy saving mode
- with 12 Volt full discharge protection
- with optical fence condition control
- with battery condition control (red LED flashes, when battery reaches about 40 % of its remaining capacity)
- with On/Off-switch
- 12 V battery terminals made from very high-quality stainless steel
- allows for solar assistance – in addition connects through mains adapter (item no. 371012) to 230 Volt mains supply

Also useable for deterring wild animals

ref. no.		€
392120	1	



type	ref. no.												
A 1000	392010	10,500 V	4,000 V	1.50 J	1.00 J	40-105 mA	35.0 km	8.0 km	3.0 km	1.0 km	2	1	
A 4000	392040	9,000 V	4,500 V	4.00 J	2.60 J	42-300 mA	75.0 km	25.0 km	4.5 km	2.0 km	10	3	
A 10000	392120	11,000 V	5,500 V	7.40 J	4.80 J	41-450 mA	120.0 km	40.0 km	15.0 km	6.0 km	20	4	

Solar Panels and Accessories

- reduced maintenance for rechargeable battery systems
- longer battery service life due to constant charging (discharge reduction)
- 10-year warranty



As environmentally friendly and innovative farmer you can achieve even more: Become your own power supplier to activate your fence system – by the most ecological way on earth to generate power.

Solar Panel for Euro Guard A Energizers

- self-adjusting - when dimensioning is correct
- incl. galvanised bracket for metal battery box and connection cable (metal battery box and device not included in delivery)
- 10 years warranty

- 375156 15 w solar panel for NA 1200
 375151 15 w solar panel for A 1000, A 130, A 150
 375251 25 w solar panel for A 350
 375256 25 w solar panel for A 4000, NA 2300
 375401 45 w solar panel for A 10000

375151

375256

ref. no.	description		€
375156	15 w solar panel	1	
375151	15 w solar panel	1	
375251	25 w solar panel	1	
375256	25 w solar panel	1	
375401	45 w solar panel with charging control	1	

Solar Panels for Euro Guard S Energizers

- includes galvanised holder and connecting cable for the device (device not included)
- self-adjusting - when dimensioning is correct
- 10 years warranty

- 375156 15 w solar panel for S 2600
 375256 25 w solar panel for S 4600

375156

foolproof installation of solar panels (without the use of tools)

ref. no.	description		€
375086	8 w solar panel	1	
375156	15 w solar panel	1	
375256	25 w solar panel	1	

Solar kit 8 W

- ecological alternative for 9 V dry battery
 - a comparative calculation will be worth it
- Included in scope of delivery:
- 1 x solar module 12 V, 8 Watts with holder
 - 1 x gel battery 12 V, 12 Ah incl. charging unit
 - 1 x 230 V mains charger

ref. no.	description		€
377040	8 watt solar kit	1	

Solar Panel 4 w

- 1 x solar module 10 volt, 4 watt with holder
- solar module supports or relieves the 9 V battery during daylight hours. The battery energiser draws power from the solar module during daylight hours. The solar module cannot be used to charge to 9 or 12 V battery.

ref. no.	description		€
377024	solar panel 4 w	1	

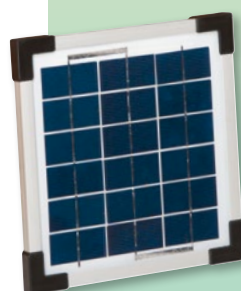
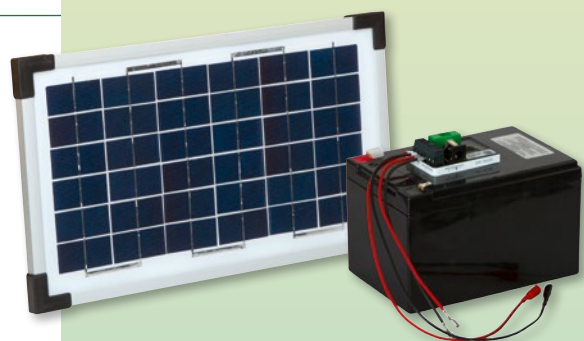

Metal Battery Boxes

Anti-Theft-Box

- electrifiable metal battery box made from galvanised steel
- external dimensions: H 37.5 cm x W 37.5 cm x D 33.5 cm
- space for battery unit max. 36.5 cm x 11 cm x 37 cm
- space for one 12 V battery max. 36.5 cm x 21.5 cm x 21 cm
- lockable, lock included in scope of supply
- delivery without device and battery

Including solid 100 cm long assembly / ground rod



ref. no.		€
44650	1	

Metal Protective Box

- especially suitable for 12 V devices
- protection for the fence energiser against environmental influences
- with transparent Plexiglas sliding door, optionally lockable
- incl. fixing screws for poles or walls
- protection from ants
- Tip: if possible, do not expose the front side of the box to direct sunlight in order to avoid high temperatures in the box
- supplied without device and battery
- external dimensions: L: 35.0 cm, W: 15.3 cm, H: 37.6 cm
- internal dimensions: L: 33.0 cm, W: 14.3 cm, H: 37.0 cm

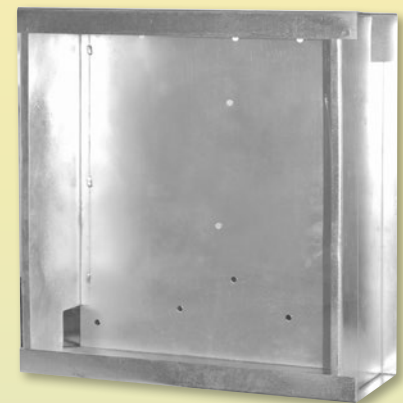

ref. no.		€
371200	1	

Metal Battery Box

- robust galvanized battery box
- convenient for transport and sheltered housing for fencer and battery
- for Akkus up to 110 Ah
- internal measurements: W x H x D: 36 x 21 x 32 cm
- supplied without device and battery
- recommended solar modules: 375151, 375251, 375401, 375256

ref. no.		€
44656	1	



Anti-Theft-Set for Metal Battery Case

- mechanical anti-theft set suitable for metal box 44656
- Set includes:
 - spiral earth (27 cm) rod with screw-in assistance and securing bolt
 - padlock
 - erection bolts with locking nut
- makes theft of electric fence energiser with battery carrying case much more difficult
- delivery without battery box

Safety tip! Thieves no longer get a look in... With the new battery box with soil anchor... and the "whole thing" can be locked!



ref. no.		€
44652	1	

9 V Battery Energizers

Portable, compact - technology you can believe in!

The 9 volt, dry battery units distinguish themselves from all others by the highest mobility and long operating life. They are excellent for shorter runs of fence with little vegetation, when there is no mains available. Alternatively they can also operate with 12 V rechargeable wet batteries.



Digital



Switch setting BATTERY:
Special battery test under load allows a realistic test of the condition of the 9 volt alkaline or 12 volt rechargeable battery.



Switch setting:
1 ECON Lower power output with longer gaps between pulses
2 NORMAL Maximum power output with longer gaps between pulses
3 EXTREM Maximum power output with short gaps between pulses
4 AUTO The unit reacts automatically to fence conditions and varies the output and gaps between pulses accordingly

Euro Guard B digital

- 9 V battery unit with extremely high power output - for all types of animals
- equipped with a digital display (illuminated when in use) for output voltage and battery voltage
- 4 power levels – meaning the power can be adjusted to the respective fencing conditions and the power consumption can be efficiently regulated
- uses a 9 volt alkaline battery
- includes combined earthing rod/unit holder
- units can also be operated with 12 V rechargeable batteries
- integrated 12 V full discharge protection
- power save switch/energy recovery
- microprocessor technology
- rotary switch allows easy operation

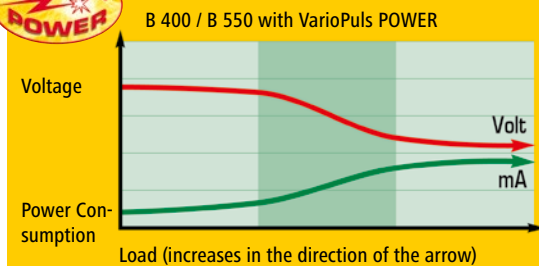
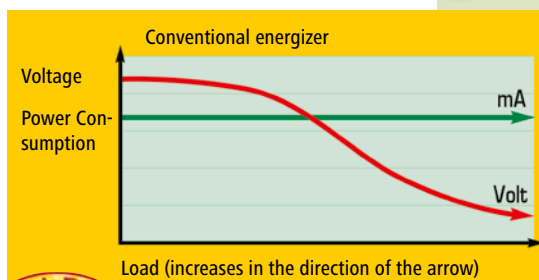

This DUO-LED displays the status of the fence and the battery. It blinks in rhythm with the fence pulse in the following colours: The LED blinks green when the fence output voltage and battery voltage are high. The colour turns red when the fence output voltage and/or the battery voltage falls below the lower limit. In

this case, the fence system or the battery must be inspected.

ref. no.	description	€
391040	Euro Guard B 400 digital	1
391055	Euro Guard B 550 digital	1

9 V Battery Energizers



Euro Guard B 200

For smaller and medium fence lines without vegetation, especially for cattle and horse containment.

- high output power
- low power consumption
- operates on 9 volts dry battery
- indicator light to control fence condition and battery
- robust and impact-resistant plastic casing
- qualifies to current European Safety Regulations
- allows for 12 V operation

ref. no.		€
390020	1	



Euro Guard B 280

- unit provides strong shocks for use with all types of animals
- ideal electrical fence unit for average fence lengths with sparse vegetation
- with the manual rotary switch, the shock strength can be set at 5 different levels - power consumption can be efficiently controlled and adjusted for the respective fencing conditions
- easy to use
- visual control of fence voltage
- visual control of battery voltage
- extremely robust housing with innovative locking/sealing technology
- new, convenient holding rod for easy, secure positioning
- 12 volt operation possible

ref. no.		€
391028	1	



Euro Guard B 350

- very effective 9 volt universal battery unit for fences with sparse vegetation
- 5-step adjustable impact force using the manual rotary switch – meaning the power consumption can be efficiently controlled and adapted to the respective fencing conditions
- easy to use
- visual control of fence voltage
- visual control of battery voltage
- extremely robust housing with innovative locking/sealing technology
- new, convenient holding rod for easy, secure positioning
- 12 volt operation possible

ref. no.		€
391035	1	



Adaptor Cable

- with 80 cm cable • connects 12 Volt wet rechargeable battery
- for connection to all our 9 V electrical fences

ref. no.		€
44641	1	



type	ref. no.											
B 200	390020	9,300 V	2,500 V	0.25 J	0.16 J	25-39 mA	3.0 km	1.5 km	0.2 km	-	-	1
B 280	391028	11,000 V	3,000 V	0.35 J	0.23 J	11-27 mA	4.5 km	3.0 km	0.3 km	-	-	1
B 350	391035	11,000 V	3,300 V	0.40 J	0.30 J	14-36 mA	7.0 km	4.0 km	0.5 km	-	-	1
B 400	391040	10,000 V	3,400 V	0.45 J	0.32 J	13-40 mA	7.0 km	4.0 km	0.5 km	-	-	1
B 550	391055	10,500 V	3,800 V	0.60 J	0.45 J	17-50 mA	10.0 km	4.5 km	2.5 km	0.4 km	-	1

9 V Battery Energizers

Euro Guard B 300 Multi

- highly effective 9 Volt universal battery device for fences with low vegetative growth
- 5-step adjustable impact force using the manual rotary switch – meaning the power consumption can be efficiently controlled and adapted to the respective fencing conditions
- easy handling
- control display for fence voltage
- control display for battery voltage
- extremely robust housing with innovative locking technology
- new convenient supporting rod for secure and easy positioning
- 12 volt operation also possible
- 230 volt operation also possible

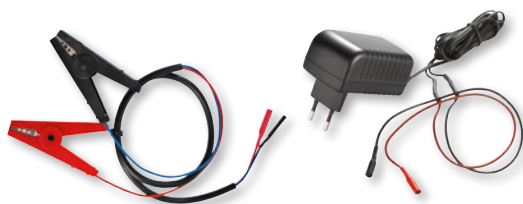

ref. no.		€
391025	1	



type	ref. no.										
B 300 Multi	391025	11,000 V	3,300 V	0.39 J	0.28 J	10-25 mA	6.0 km	3.5 km	0.4 km	-	1

Farm Patrol - DUO Units

DUO Units 2 in 1

Two power input options available - 230 V mains supply or 12 V battery units. That means the unit can be used for permanent fencing with 230 V mains supply and also for mobile fencing with 12 V primary or rechargeable batteries. As a standard, the devices are delivered with a 12 V supply cable (incl. stainless steel clamps), with 230 V mains adapter and with fence and earth connecting leads. Casing is splash water resistant and allows an outdoor installation without any problems. When the unit is operated above 230 V the mains adapter should be installed indoors.

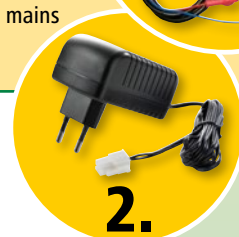

Farm Patrol A 130

- DUO unit for medium fence systems with low vegetation
- latest electric fencing technology - microprocessor controlled
- optimized consumption thanks to energy saving mode
- full discharge protection with 12 V operation
- function control display
- battery monitoring indicator
- 3 years warranty
- Made in Germany

ref. no.		€
363525	1	



type	ref. no.										
A 130	363525	8,900 V	4,000 V	1.50 J	1.00 J	25.0 km	6.5 km	2.0 km	0.5 km	2	1

Farm Patrol - 9 volt battery energizers

Farm Patrol B 160

- compact 9V battery unit for short fencing systems without vegetative growth
- ideal for horse and cattle paddocks
- low power consumption
- indicator light to control fence condition and battery
- weather-proof casing
- 12 Volt operation possible (use adaptor cable item no. 44641, not included in delivery)
- 3 years warranty
- Made in Germany











ref. no.		€
363500	1	

Farm Patrol B 300

- efficient 9 V battery unit for medium fencing systems
- universal use
- low power consumption
- indicator light to control fence condition and battery condition
- choice of two power levels
- weather-proof casing
- 12 Volt operation possible (use adaptor cable item no. 44641, not included in delivery)
- 3 years warranty
- Made in Germany



ref. no.		€
363501	1	

type	ref. no.							
B 160 / 9 V	363500	2,300 V	0.25 J	0.16 J	25-39 mA	3.0 km	2.0 km	0.5 km
B 300 / 9 V	363501	3,100 V	0.54 J	0.34 J	34-50 mA	6.0 km	4.0 km	1.5 km

Farm Patrol 230 Volts Mains Energizers

Farm Patrol N 1000

- powerful 230 V power supply unit
- universally suitable for standard fences
- for horses, cattle and sheep
- microprocessor controlled
- latest electric fencing technology - microprozessor controlled
- 3 years warranty
- Made in Germany

ref. no.		€
363535	1	



Farm Patrol N 3000

- very effective 230 volt all-round power supply
- can be used with light to medium vegetative growth
- optical fence voltage control and earth control on LED (a flashing red light indicates a fault)
- latest electric fencing technology - microprozessor operation
- 3 years warranty
- Made in Germany

ref. no.		€
363536	1	













Farm Patrol N 6000

- highly efficient 230 V power supply unit - our all-round product can be used with medium to heavy vegetative growth; for horses, cattle, sheep, goats and for deterring wild animals
- visual fence voltage display and separate visual earthing display (a flashing red light indicates a fault)
- latest electric fencing technology - microprozessor operation
- manufactured in accordance with the new European safety standard EN60335
- 3 years warranty
- Made in Germany

ref. no.		€
363537	1	



type	ref. no.											
N 6000	363537	10,000 V	5,900 V	7.00 J	5.00 J	140.0 km	45.0 km	8.0 km	4.0 km	12	3	2
N 3000	363536	10,000 V	5,700 V	4.50 J	3.10 J	85.0 km	25.0 km	4.0 km	2.0 km	7	3	-
N 1000	363535	10,000 V	4,000 V	1.80 J	1.30 J	40.0 km	10.0 km	2.5 km	0.8 km	3	1	-

Farm Patrol - 12 volt battery-operated devices

Farm Patrol A 150

- effective 12 V device for short fencing systems with medium vegetative growth - for horses, cattle and even small animals such as dogs, cats and poultry
- latest electric fencing technology - microprozessor controlled
- optimized consumption thanks to energy saving mode
- fence monitoring indicator
- separate battery monitoring indicator
- 12 V full discharge protection
- allows for solar assistance (recommended solar panel 15 w; 375151)
- 3 years warranty
- Made in Germany













ref. no.		€
363516	1	

Farm Patrol A 350

- 12V device with high output power for normal fencing systems, even with heavier vegetative growth
- for horses, cattle, deterring wild animals and sheep
- latest electric fencing technology - microprozessor operation
- fence monitoring indicator
- separate battery monitoring indicator
- 12 V full discharge protection
- allows for solar assistance (recommended solar panel 25 w; 375251)
- 3 years warranty
- Made in Germany



ref. no.		€
363517	1	

type	ref. no.										
A 350	363517	10,000 V	4,800 V	4.30 J	3.00 J	70.0 km	25.0 km	4.0 km	2.0 km	7	3
A 150	363516	10,000 V	4,700 V	2.00 J	1.60 J	45.0 km	15.0 km	3.5 km	1.0 km	5	2

Fencing- and Safety Products

GSM Alarm with Remote Switch

Alarm function:

The new GSM Alarm now also allows you to easily monitor your remote fence systems. If the minimum tending voltage falls below a certain level (you can set this individually) or fails completely, the GSM Alarm sends a corresponding message via SMS to your mobile phone. The measured fence voltage, the pulse cycle, the current battery voltage of the GSM Alarm's supply battery and also of its internal system battery are notified to you via SMS. Additional alarm devices (combined signal generator, Art. No. 441035) can also optionally be connected via cables to the relay contact on the GSM Alarm. The GSM Alarm works with most commercially available electric fence units.

It is possible at any time to request a status report from the GSM-Alarm via SMS.

The GSM alarm is operated either via the same battery (9 V or 12 V) as the electric fence unit or independently via a separate 9 V or 12 V battery (especially if the GSM-Alarm is not positioned directly on the electric fence unit). There must be a mobile telephone network connection at the site of the GSM-Alarm. The SIM card required is not included.

Remote switching function via SMS or call:

You can also switch any 9 or 12 V electric fence unit on or off if it is connected to the GSM-Alarm. In combination with the ON/OFF switching adapter Art.No. 441030, any 230 V device can be switched ON or OFF.



ref. no.	description		€
441033-230	GSM Alarm (230 volts)	1/5	
441033-12	GSM Alarm (12 volts)	1/5	
441033-9	GSM Alarm (9 volts)	1/5	
441030	On / off switching adapter for 230 volts units	1	
441035	Combination signal generator (flashing light + siren)	1	

Fence Controller

- for accurate fault finding in your electric fence.
- This is a dual function device - it is a digital fence voltage tester and ammeter. This enables simple detection of possible faults on the fence.
- with illuminated direction indicators in each case.
- convenient and safe application due to ergonomic housing
- universal contact clips suitable for all conducting materials
- convenient measurement through automatic earthing

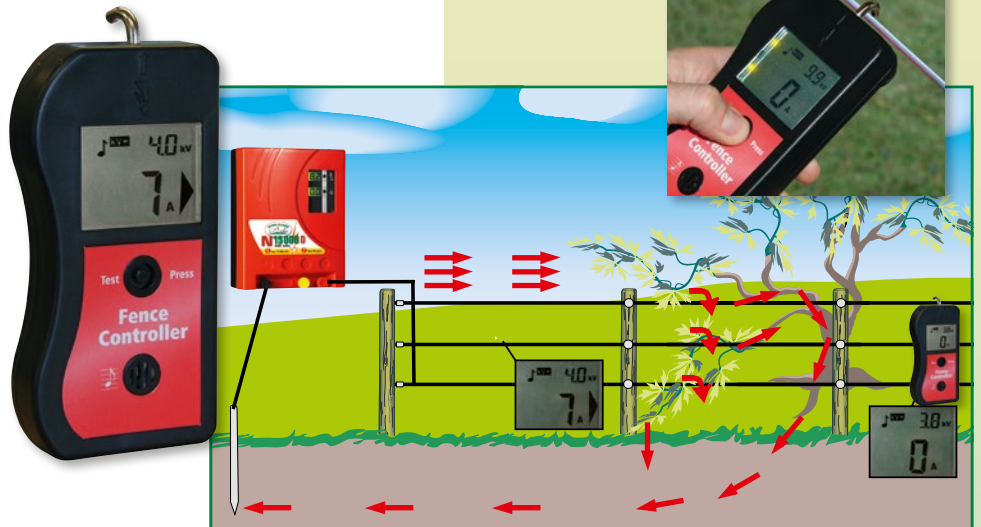

ref. no.		€
442565	1	

Signal Light

- flashes with every fence impulse
- under 3000 V light stops flashing and thereby shows that the fence is no longer safe
- mount signal lights at several points on your fence for quick optical control of the condition of your fence - also visible at daylight
- the signal light does not require batteries

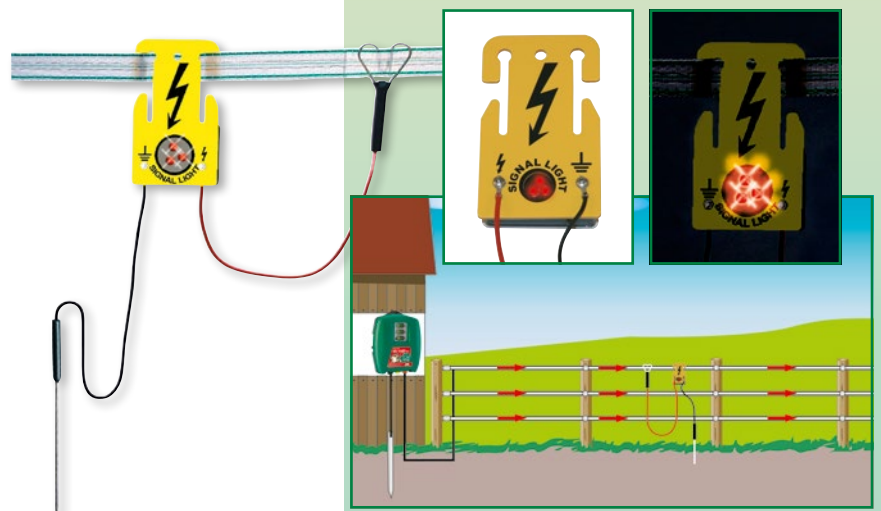

ref. no.		€
441223	1/50	

Fencing- and Safety Products

Digital Voltmeter

- to accurately measure voltages of between 0 and 9,900 volts at the fence
- incl. 9 V block battery and belt holder



ref. no.		€
441229	1	



Fence Tester

- voltage readout in 6 levels
- needs no batteries
- precise measurement of fence voltage

Our best-selling Fence Tester!

ref. no.	description			€
44661	up to 10000 V	1	100	
44662	up to 6000 V	1	100	





Fence Line Tester without Ground rod

- easy measurement, no ground rod is needed
- measurement in the distance to the hedge of max. 0 - 5 cm
- voltage readout in four levels shown in four flashing green diodes: 2500 V – 8000 V
- red LED for undervoltage
- LED display for battery status (9 V block)
- incl. 9 V block battery

1. st place
Cavallo-Test, June 2010



ref. no.			€
44669	1	80	



Fence Checker

Visual and Audible Hedge Tester

- mini handheld display device for electric fences
- emits auditory and visual signals when the fence has a voltage
- incl. battery test function
- takes readings easily without the need for an earth spike
- incl. battery

ref. no.		€
441227	1	

Perfect for cyclists and walkers!



Hobby Kits

Portable Fence Kit for Trekking

- assembles and disassembles quickly and easily
- weight: about 3 kg

Consists of:

- 1 battery energiser of 3 V (incl. 2 x 1.5 V batteries)
- 2 gate handles with 50 m tape each
- 4 divisible aluminium posts of 1.15 m length
- 5 x expanders with pegs
- 8 insulators for round posts
- 1 carry bag



ref. no.		€
44127	1	

Hobbyset



The ideal fence to protect your garden and to fence in dogs and cats. Excellent to enclose ponds in order to prevent e.g. cats and herons from fishing!

Set includes:

- 1 x electric fence energiser + earth/fence connecting cable
- 10 x fibreglass poles, green 70 cm
- 30 x wire clips
- 100 m polywire green
- 1 x earth rod
- 1 x warning sign
- 6 x ring insulators with wooden thread



ref. no.	description		€
441150	Hobbyset with Mains Unit N700	1	
441151	Hobbyset with Battery Unit B40	1	



ref. no.	description			€
441853	Spare Post 70 cm	-	1	
444265	Spare spring	30	1/30/1500	
44874-100	Green polywire, 100 m	-	1/20	



Underground and Grounding Equipment

Special Ground Rod

- made of galvanised T-shaped steel incl. M8 screw (stainless steel) for ground connection cable

ref. no.	length			€
44615	1 m	1	400	
441369	2 m	1	200	



Special Earth Rod for Mobile Use

ref. no.		€
44619	1	

- 75 cm length made of galvanized steel
- easy to pull out with T-handle
- with screw for earth connecting cable



Cast Resin Connection Kit

ref. no.		€
440120	1	

- for creating high-voltage-proof, water-tight connection of underground cables

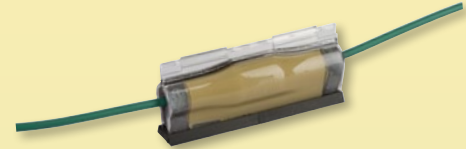

High-Voltage Underground Cable Premium

- double-insulated with tinned copper conductor
- connects fence line and grounding
- on plastic reel
- high voltage insulation up to 20.000 Volt

ref. no.	length	conductor diameter	conductor cross-section	exterior diameter	resistance Ω/m		€
440110	50 m	1,6 mm	1,5 mm ²	7,6 mm	0,014	1	
440111	100 m	1,6 mm	1,5 mm ²	7,6 mm	0,014	1	



High-Voltage Underground Cable

- double-insulated with galvanized steel conductor
- connects fence line and grounding
- ideal for permanent fence systems

ref. no.	length	conductor diameter	conductor cross-section	exterior diameter	resistance Ω/m		€
44818	25 m	1,6 mm	2,0 mm ²	6,1 mm	0,090	1	
44921	50 m	1,6 mm	2,0 mm ²	6,1 mm	0,090	1	
44922	100 m	1,6 mm	2,0 mm ²	6,1 mm	0,090	1	
44819	50 m	2,5 mm	4,9 mm ²	7,1 mm	0,035	1	
44920	100 m	2,5 mm	4,9 mm ²	7,1 mm	0,035	1	

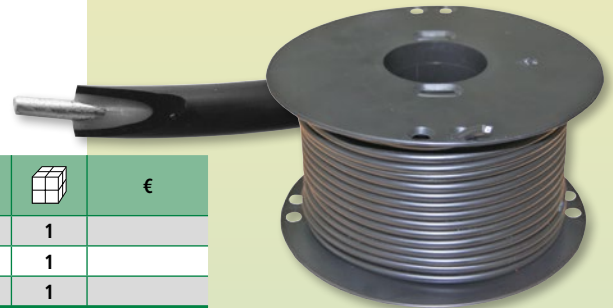

High-Voltage Underground Cable

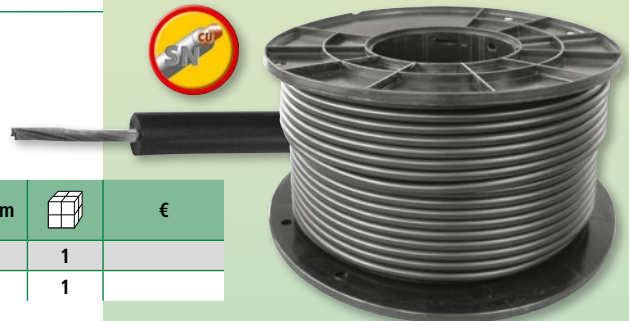

- single-insulated with tinned copper conductor (bundled copper wires)
- connects fence line and grounding
- on plastic reel

ref. no.	length	conductor diameter	conductor cross-section	exterior diameter	resistance Ω/m		€
44630	25 m	1,32 mm	1,0 mm ²	7,0 mm	0,025	1	
44632	50 m	1,32 mm	1,0 mm ²	7,0 mm	0,025	1	



Fence/Earth Connection Cable

- with M8 eyelets
- connects fencer and ground rod
- excellent connection between indoors energizer to outside ground rod
- also suitable for connecting several ground rods

ref. no.	length			€
44635	3 m	1	40	
44636	8 m	1	15	



Batteries

12 Volt Special Wet Rechargeable Battery

- extremely low self-discharge
- ideal for 12 V battery units with or without solar panel
- designed especially for fencing units due to its slow charge and discharge cycles
- acid: sulphuric acid 37 % = density of 1.28
- supplied without acid
- during storage (e.g. in winter), the battery must be charged at least once

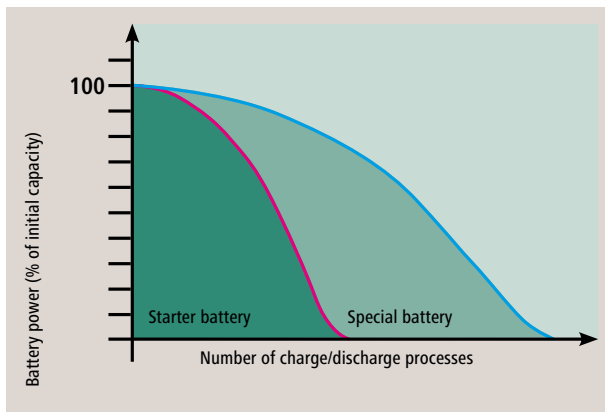

Attention: For safety reasons delivery without battery acid. We recommend to have the battery filled by a technician on site!

12 volts 85 Ah fits Anti-Theft-Box 44651
12 volts 110 Ah fits metal battery box 44656

ref. no.	description	l x w x h	acid		€
350535	12 V, 65 Ah	242 x 175 x 190 mm	3,20 l	1	
44233	12 V, 85 Ah	278 x 175 x 190 mm	3,70 l	1	
44223	12 v, 110 Ah	353 x 175 x 190 mm	5,00 l	1	
442161	Battery acid bottle	-	1,00 l	1/4	

Battery Charger for 12 V and 24 V Lead Acid Batteries

- charging voltage: 14.4 V or 28.8 V
- charging current: 1.5 A - 10.0 A (charging energy)
- fitted with two removable and interchangeable colour-coded leads (1 x crocodile battery terminal & 1 x eyelet)
- electronically protected against misuse
- protection circuit against overheating with mini-fan inside
- protected against short circuits and incorrect connections
- for 12 V batteries 14 - 230 Ah (capacity)
- can also be used as a power generator (13.6 V / 5.0 A)!

ref. no.		€
371017/016	1	



Batteries

Dry Battery ALKALINE 9 Volt

- 9 V alkaline batteries keep a constantly high voltage during their entire battery life. This allows the fence to provide the fence line with a constant amount of energy
- free of mercury and cadmium

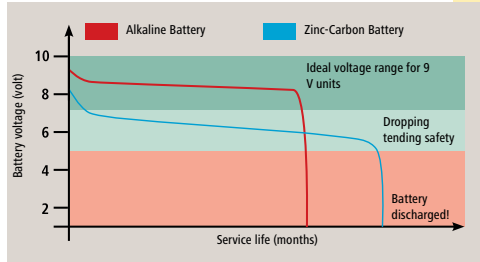

All prices include disposal fee!

ref. no.	description	use			€
44225	9 V, 75 Ah	small case	1/4	360	
44228	9 V, 120 Ah	small case	1/4	360	
44226	9 V, 170 Ah	big case	1/4	216	



Zinc-Carbon Dry Battery 9 volts



44218



44227

All prices include disposal fee!

ref. no.	description	use			€
441212	9 V, 55 Ah	small case	1/4	320	
441213	9 V, 90 Ah	large case	1/4	192	
441219	9 V, 130 Ah	large case	1/4	192	
44227	7,5 V, 90 Ah	round case	1/4	120	
44218	Tent Lamp Battery 6 V, 7 Ah	Portable Lamp	1/24	1,008	



Power Gel Complete Set

- for all 9 V devices that are also designed for 12 V operation
- the rechargeable 12 V, 12 Ah gel battery can be recharged via a mains charger adapter
- the integrated charger controller prevents overcharging
- an optional 8 Watt solar module can also be connected during grazing periods for continual operation

New!



ref. no.		€
441215	1	

supplied package: gel battery 12 V, 12 Ah - 230 V mains charger - charge controller

Zinc-Carbon Dry Battery round

- 10,5 V / 90 Ah
- green case
- with 3 mounting eyes
- price includes disposal fee
- type cowboy

ref. no.		€
44230	1/4	



Connection and Grounding Accessories

Earting Cable insulated

- connects energizer and ground rod
- lead length 100 cm
- M8 metal eyelets

ref. no.		€
44604	1	

Fence Connecting Cable Heart-shaped Clip

- connects fencer and wire or polywire
- lead length 125 cm
- heart-shaped clip

ref. no.		€
441603	1	

Stainless steel

Earting Cable

- with heavy-duty crocodile clip
- lead length 100 cm
- M8 metal eye

ref. no.		€
44606	1	

Stainless steel

Fence Connecting Cable

- with heavy-duty crocodile clip
- lead length 100 cm
- M8 metal eye

ref. no.		€
44605	1	

Stainless steel

Fence Connection Cable

- with 2 heavy-duty crocodile clips
- lead length 60 cm

ref. no.		€
441608	1	

Stainless steel

Adaptor Cable

- with 80 cm cable • connects 12 Volt wet rechargeable battery
- for connection to all our 9 V electrical fences

ref. no.		€
44641	1	

Connecting Cable

- for connection of a 12 V accumulator or 12 V wet battery
- with 2 heavy-duty crocodile clips
- length 100 cm
- with M8 metal eyes

ref. no.		€
44640	1	

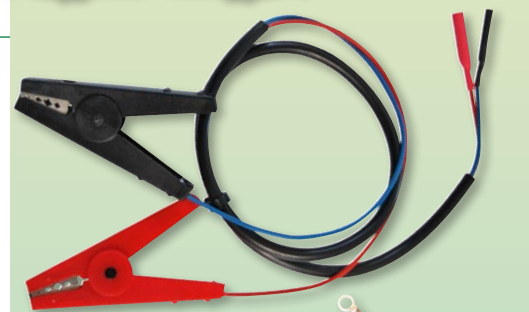
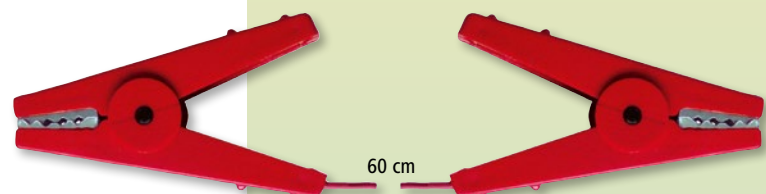
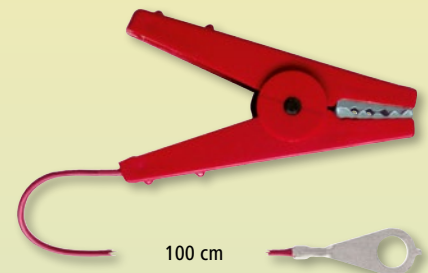
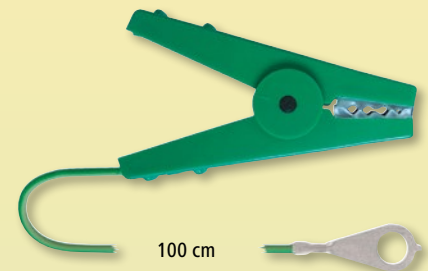
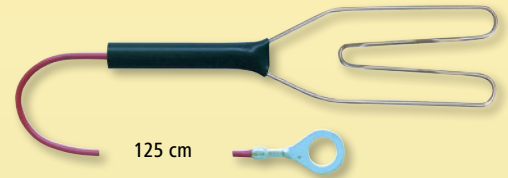

Connection and Grounding Accessories

Energizer-to-tape connector

- ideal mechanical and electrical connection between energizer and tape up to a width of 40 mm
- 130 cm lead
- M8 eye

ref. no.		€
44617	1	

Stainless steel

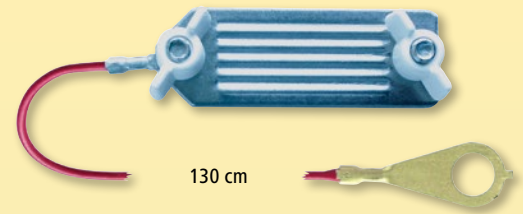

Tape Connector

- ideal mechanical and electrical connection between two fencing tapes up to a width of 40 mm
- 80 cm lead

ref. no.		€
44616	1	

Stainless steel

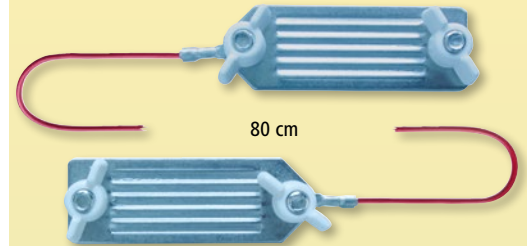

Tape-to-tape Connector

- with two plastic clamps up to 40 mm
- length 80 cm
- safe and trouble-free between two tapes or Polywires

ref. no.		€
44608	1	



Rope-to-rope Connector

- connector for ropes up to 6.5 mm
- ideal mechanical and electrical connection between two fencing ropes up to \varnothing 6.5 mm
- 80 cm lead

ref. no.		€
44629	1	



Rope / Tape Connection

- the perfect mechanical and electrical connection between pasture fence rope (up to \varnothing 6.5 mm) and pasture fence tape (up to 40 mm)
- 80 cm cable

ref. no.		€
441493	1	

Stainless steel

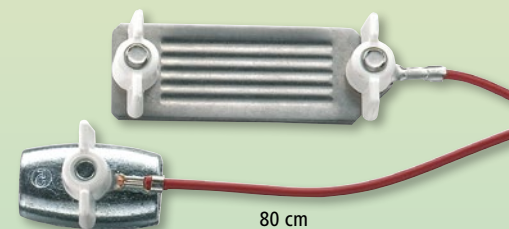

Rope Connector

- ideal mechanical and electrical connection between energizer and fencing rope up to \varnothing 6.5 mm
- 150 cm lead
- M8 eye

ref. no.		€
44627	1	

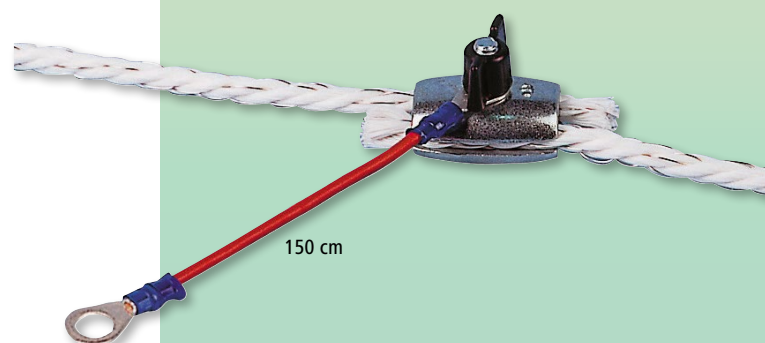

Wooden Posts for Permanent Fencing



Octo Wood

- the new Octo Wood post with the ingenious octagonal profile made of Pinus Silvestris = pine wood
- thus provides simple mounting without pre-drilling
- this post is also well-suited for erecting a wooden fence
- furthermore, the octagonal profile also ensures a secure rest in pallets and allows for excellent transportation without rolling
- highly effective pressure impregnation with ecological wood protection preservative in accordance with 68800-3 Standard
- sensational 10-year warranty!

ref. no.	description	total height	Ø			€	
441827	Corner-/gate post	200 cm	140 mm	1	48		
441828	Corner-/gate post	250 cm	140 mm	1	48		
441820	Fence Line post	150 cm	60 mm	1	252		
441821	Fence Line post	200 cm	60 mm	1	252		
441822	Fence Line post	180 cm	80 mm	1	154		
441823	Fence Line post	200 cm	80 mm	1	154		
441824	Fence Line post	225 cm	80 mm	1	154		
441825	Fence Line post	200 cm	100 mm	1	99		
441826	Fence Line post	225 cm	100 mm	1	99		
441835	Cross bar 3.5 m	-	-	1	99		

Raw materials

OctoWood uses only slow-growing Scandinavian pine grown north of 64 degrees latitude:

- low temperatures
- short sunlight hours
- smaller tree crowns
- straight trunk
- extremely rigid
- high breaking load

Consistent growth rings = steady growth

Narrow growth rings = slow growth

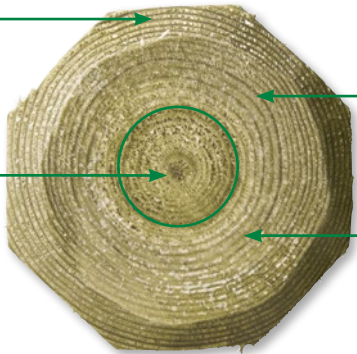

Heartwood

- does not have to be waterproofed
- contains the natural fungus inhibitor "pinosylvlin"
- with resin channels throughout
- "dead" wood
- gives the pole stiffness

Sapwood

- only the sapwood section is waterproofed
- the membrane of the wood fibre cell is coated in a copper sulphate layer
- waterproofed with Wolmanit CX in a pressure tank process

Hoch much copper sulphate is inserted into the Heartwood?
CTBA 9,4 kg/m3



- + 165 cm
- + 150 cm
- + 135 cm
- + 120 cm
- + 105 cm
- + 90 cm
- + 75 cm
- + 60 cm
- + 45 cm
- + 30 cm
- + 15 cm
- +/- 0 cm
- 15 cm
- 30 cm
- 45 cm
- 60 cm

T-Post System



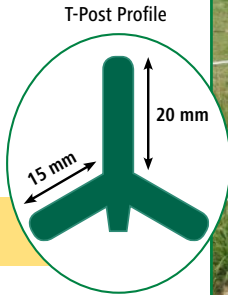

Top-quality T-Posts in varying lengths, easily driven in, for durable application. The posts have solid nubs every 5.5 cm across their entire length to fasten accessories. A solid base plate provides additional stability. The posts are painted to make them weatherproof. We recommend approx. 30 cm longer T-Posts to be used for corner posts. Insulators are fastened by clipping firmly to the T-Post at the desired heights.

Metal T-Post

- made from robust steel
- green/white painted
- with solid base plate
- drive into the ground about 40 cm
- perfect for horses, cattle and wild animal fences



it has proved its worth a thousand times

ref. no.	total height			€	
441460	152 cm	1/5	200		
441407	167 cm	1/5	200		
441461	182 cm	1/5	200		
441462	213 cm	1/5	200		

Made from rail steel - making them considerably more stable!

Support Kit T-Post

- ideal for gate systems (however, not for galvanised pasture gates)
- connects T-posts diagonally
- support kit consists of: 2 x WL101, 2 x WL102 und 2 x WL106
- important: Remove ground anchor plate for diagonal pole!

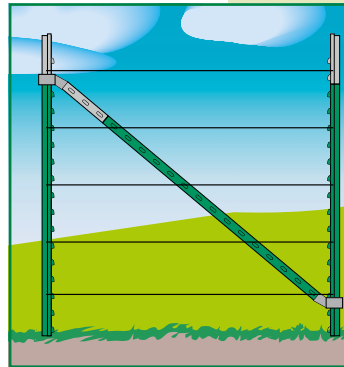

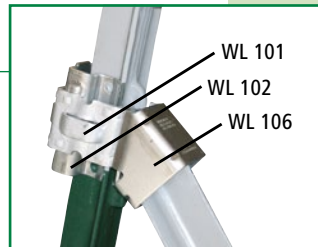

ref. no.		€
441466	1	

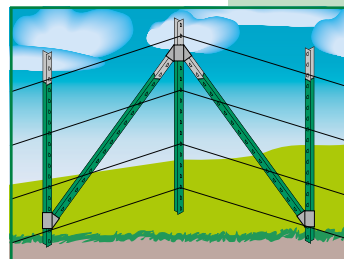

90° Corner Kits T-Post

- for installation of 90° corners with T-posts
- support kit consists of: 3 x WL101, 3 x WL102 und 4 x WL106
- important: Remove ground anchor plate for diagonal pole!



ref. no.		€
441465	1	





T-Post System

T-Post Head Insulator

- prevents animals from injuring themselves at the post top
- suits all conventional tapes, ropes, polywires and wires

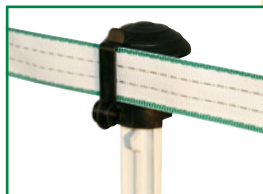

We recommend use in combination with a post top insulator

ref. no.	colour			€
441267	black	10	200	
441268	yellow	10	200	



T-Post Rope Insulator

- can be used with cable up to 8 mm, polywire, wire and tape up to 10 mm
- very robust design
- improved clip system - simplifies fastening to the T-post

ref. no.	colour			€
441189	black	25	200	
441190	yellow	25	200	





New!



T-Post Ring Insulator

- for wire, polywire, rope and tape up to 10 mm
- improved clip system - simplifies fastening to the T-post

ref. no.	colour			€
441180	black	25	200	
441181	yellow	25	200	





New!



T-Post Tape Insulator

- for tapes up to 50 mm
- improved clip system - simplifies fastening to the T-post

ref. no.	colour			€
441183	black	25	200	
441184	yellow	25	200	





New!



T-Post Pinlock Insulator

- Pinlock Insulator for rope, poly wire and wire
- improved clip system - simplifies fastening to the T-post

ref. no.	colour			€
441186	black	25	200	
441187	yellow	25	200	





New!



T-Post Distance Insulator

- distance insulator for rope, poly wire and wire
- distance of wire from post 12.5 cm
- simplifies fastening to the T-post

ref. no.	colour			€
442343	black	25	300	
442344	yellow	25	300	



T-Post System

Tape Corner Solution for T-Post

The ideal solution for T-Post corners with electric fence tape!

- for tapes up to 40 mm
- the highest quality with stainless steel
- conductor material is protected by rounded edges
- distance to post: 16.5 cm
- set includes: 4 x insulators, 4 x spacers

ref. no.	description	€
446514	Complete set	



Stainless steel

New!

Rope Corner Solution for T-Post

The ideal solution for T-Post corners with electric fence rope!

- the highest quality with stainless steel
- conductor material is protected by rounded edges
- distance to post: 16.5 cm
- set includes: 4 x insulators, 4 x spacers

ref. no.	description	€
446515	Complete set	

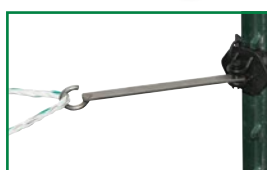

Stainless steel

New!

Gate Handle Insulator Vario for T-Post

- set includes: 3 x insulators, 3 x stainless steel connector plates each with 3 connection options

ref. no.	description	€
446516	Complete set	





Stainless steel

New!

Corner Insulator Super with metric thread

- for rope, polywire and wire • extra strong finish, very durable
- galvanised, continuous 8 mm support
- polyamide plastic for high tensile forces
- electrical discharges effectively do not arise, partly through the highly insulated post and partly through the special form of the insulator, which prevents the conductor material slipping on the metal support.
- no slipping of the conductive material on the metal support thanks to the insulator's special shape
- thread length: 30 mm / M6

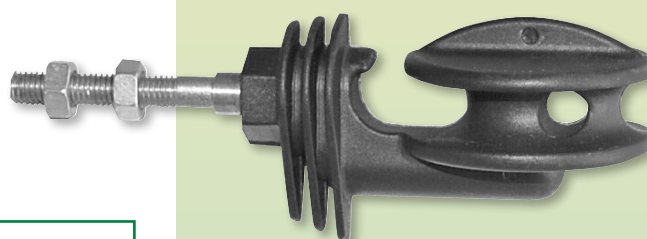

ref. no.			€
441360	10	250	



New!

Tape Corner Insulator Cavallo Metric

- for wide tapes of up to 40 mm
- extra strong finish, very durable
- galvanised, continuous 8 mm support for 100 % stability
- polyamide plastic for high tensile forces
- free-running tape is fed through safely thanks to smooth, rounded surface
- thread length: 30 mm / M6

ref. no.			€
441377	10	250	



New!

T-Post System

T-Post Tape Insulator for Gate Handle Kit T-Post

- kit comprises: 2 insulators with stainless steel plates and 4 T-Post universal clamps
- robust tape insulator with stainless steel connecting plate for gate handle and pasture fence connection (gate handle not supplied)

ref. no.	description	€
441494	Kit complete	

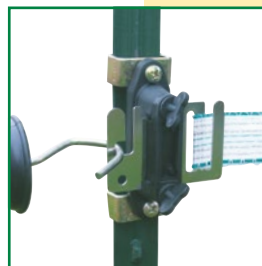

T-Post Universal Clamp Kit T-Post

- kit comprises: 2 universal clamps and 2 fastening screws
- usage on the T-Post enables universal fitting of all insulators with M6 metric thread or with 6 mm diameter hole

ref. no.	description	€
44790	Kit complete	

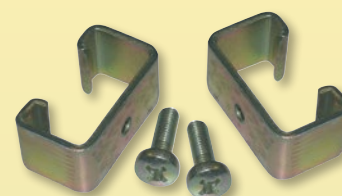

Gate Handle Insulator T-Post

Set includes:
4 x gate handle insulator + 2 x T-post universal clamp kit

ref. no.	description	€
441231	Kit complete	



Tape Insulator and Corner Insulator T-Post

Set includes:
4 x tape insulator + 4 x universal clamp kit

ref. no.	description	€
441232	Kit complete	

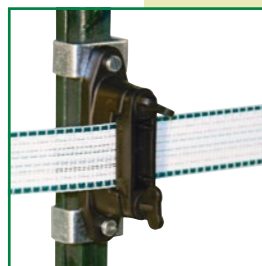

Rope Insulator and Corner Insulator T-Post

Set includes:
4 x rope insulator + 2 x universal clamp kit

ref. no.	description	€
441233	Kit complete	

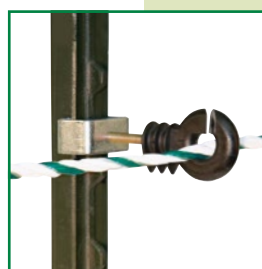

Ram for T-Post

- makes it easy to drive the t-post into the ground
- weight: approx. 8 kg

ref. no.		€
441324	1	



Pulling Device for T-Post

- enables the easy dismantling of your T-post

ref. no.		€
441300	1	



Plastic Posts

Plastic Post

- round Ø 19 mm • with galvanized spike • 5 years UV warranty
- spike 21 cm

ref. no.	colour	total height	spike	description			€
44400	white	108 cm	20 cm	without step	10	1,000	
44405	white	110 cm	24 cm	with step	10	1,000	
44499	white	158 cm	24 cm	with step	10	1,000	

Additional Eyelets for Plastic Posts

- as additional eye for plastic posts Ø 19 mm
- for polywires and tapes
- adjustable height

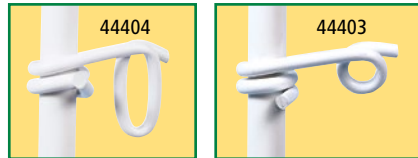

ref. no.	plastic eye for				€
44403	Polywire and Tape up to 10 mm	25	-	1,000	
44403/306	Polywire and Tape up to 10 mm	-	30	-	
44404	Tape up to 40 mm	25	-	750	
44404/306	Tape up to 40 mm	-	30	-	

Round Fibreglass Post made from solid material

- yellow • ground nail made from fibreglass • low weight • round shape, 12 mm diameter
- extremely robust design with step • ideal for cattle, horse and sheep pens • insulators not included in the scope of delivery • 5 years UV warranty

ref. no.	total height	Ø	spike			€
441852	125 cm	12 mm	20 cm	10	1,750	
441856	140 cm	12 mm	20 cm	10	1,750	
441858	160 cm	12 mm	20 cm	10	1,750	

Plastic Eyelets for round fibreglass post

for round fibreglass post

- suitable for fibreglass posts of diameter 12 mm
- for stranded wires and wires • height-adjustable

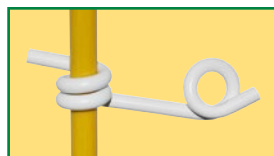

ref. no.	Ø			€
444012	12 mm	50	1,000	

Oval Fibreglass Post

- yellow/black • oval • perfect for keeping cows, horses and sheep
- 444271, 444272, 444262: head insulator and height-adjustable additional insulator are included • 444269/10: head insulator with metal ring are included • ideal for stranded wires, wire and tapes up to 20 mm • 5 years UV warranty

These posts impress with low weight and volume (alpine use, rotating pastures) as well as their unbelievable sturdiness!

ref. no.	total height	description	Oval Post			€
444271	110 cm	18 cm, metal	10 x 8 mm	10	1,750	
444272	154 cm	18 cm, metal	10 x 8 mm	10	1,750	
444269/10	106 cm	18 cm, metal	10 x 6 mm	10	1,000	
444261	110 cm	22 cm, fibre glass	10 x 8 mm	10	1,750	

Spare / Additional Insulator

- variable height of wire
- absolutely secure attachment

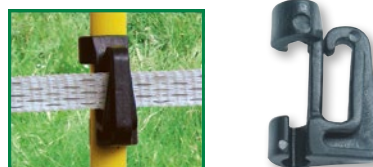

ref. no.	use			€
444263	Spare isulator for 444272	25	-	

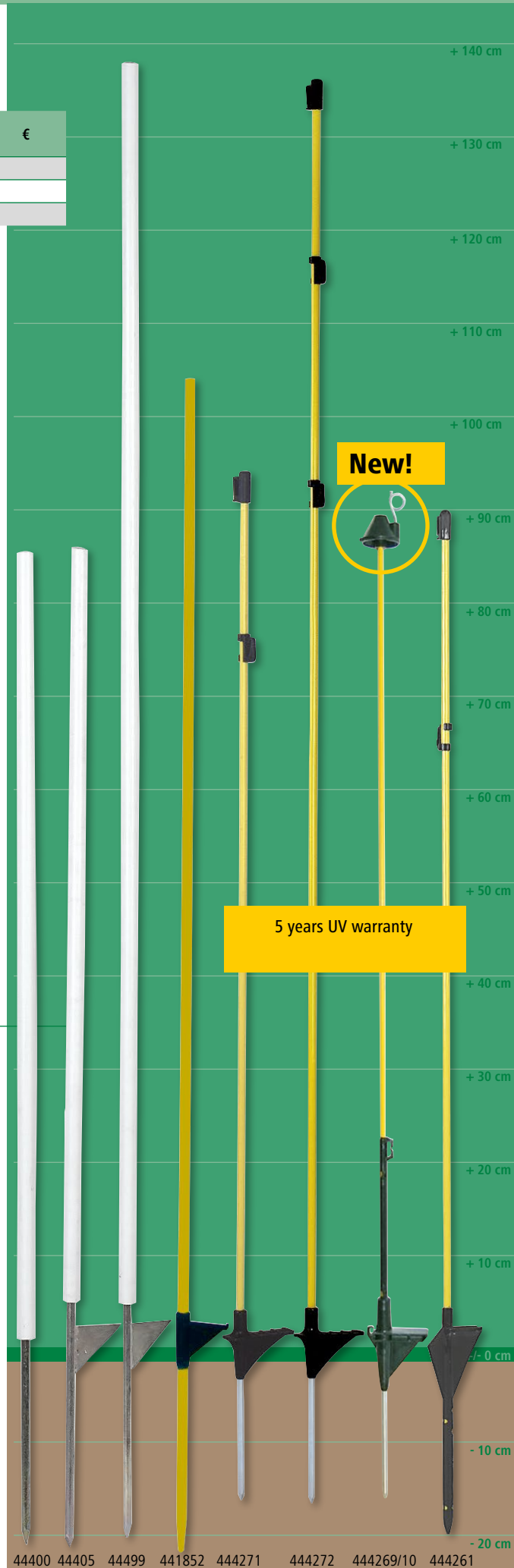

+140 cm
+130 cm
+120 cm
+110 cm
+100 cm
+90 cm
+80 cm
+70 cm
+60 cm
+50 cm
+40 cm
+30 cm
+20 cm
+10 cm
0 cm
-10 cm
-20 cm

44400 44405 44499 441852 444271 444272 444269/10 444261

Plastic Posts

Titan PLUS

- metal step-in reinforcement provides extremely high stability
- highly impact-resistant, high-grade plastic, virtually unbreakable
- also suited for sub-zero temperatures
- for all commonly available tapes, ropes, stranded or solid wires
- high stability through additional longitudinal struts
- with galvanized spike



Metal step-in reinforcement provides extremely high stability

with special honeycomb structure

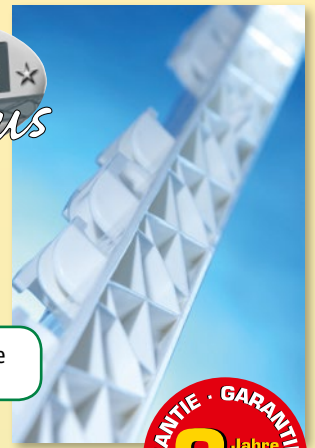

ref. no.	colour	total height	spike	eyes			€
4418083	blue	108 cm	16 cm	5 x rope + 3 x tape	5	490	
441808	white	108 cm	16 cm	5 x Rope + 3 x Tape	5	490	
441809	white	155 cm	19 cm	7 x Rope + 5 x Tape	5	500	

Plastic Post Titan

with double prong

- highly impact-resistant, high-grade plastic, virtually unbreakable
- also suited for sub-zero temperatures
- for all common tapes, ropes, stranded or solid wires
- high stability through additional longitudinal struts
- with two galvanized spikes



with special honeycomb structure



ref. no.	colour	total height	spike	eyes			€
441806	white	110 cm	18 cm	5 x Rope + 3 x Tape	5	490	
441807	white	157 cm	20 cm	7 x Rope + 5 x Tape	5	500	

Plastic Post Eco

- for all commonly available tapes, ropes, stranded or solid wires
- high stability through additional longitudinal struts
- with galvanized spike

ref. no.	colour	total height	spike	eyes			€
441810	white	70 cm	18 cm	5 x tape/rope	5	1,200	
4418102	green	70 cm	18 cm	5 x tape/rope	5	1,200	
441812	white	105 cm	18 cm	7 x tape/rope + 1 x tape	5	1,000	

Classic Plastic Post

- for all conventional tapes, polywires, ropes and wires vertically
- reinforced for increased stability
- with galvanized spike

ref. no.	colour	total height	spike	eyes			€
44497	white	105 cm	17 cm	5 x rope, 2 x 20 mm tape, 1 x 40 mm tape	5	720	
443412	white	156 cm	21 cm	4 x rope, 3 x 20 mm tape, 4 x 40 mm tape	5	750	
443413	white	105 cm	18 cm	2 x rope, 3 x 20 mm tape, 2 x 40 mm tape	5	630	

Plastic Posts

Titan PLUS

Titan

Eco

Classic

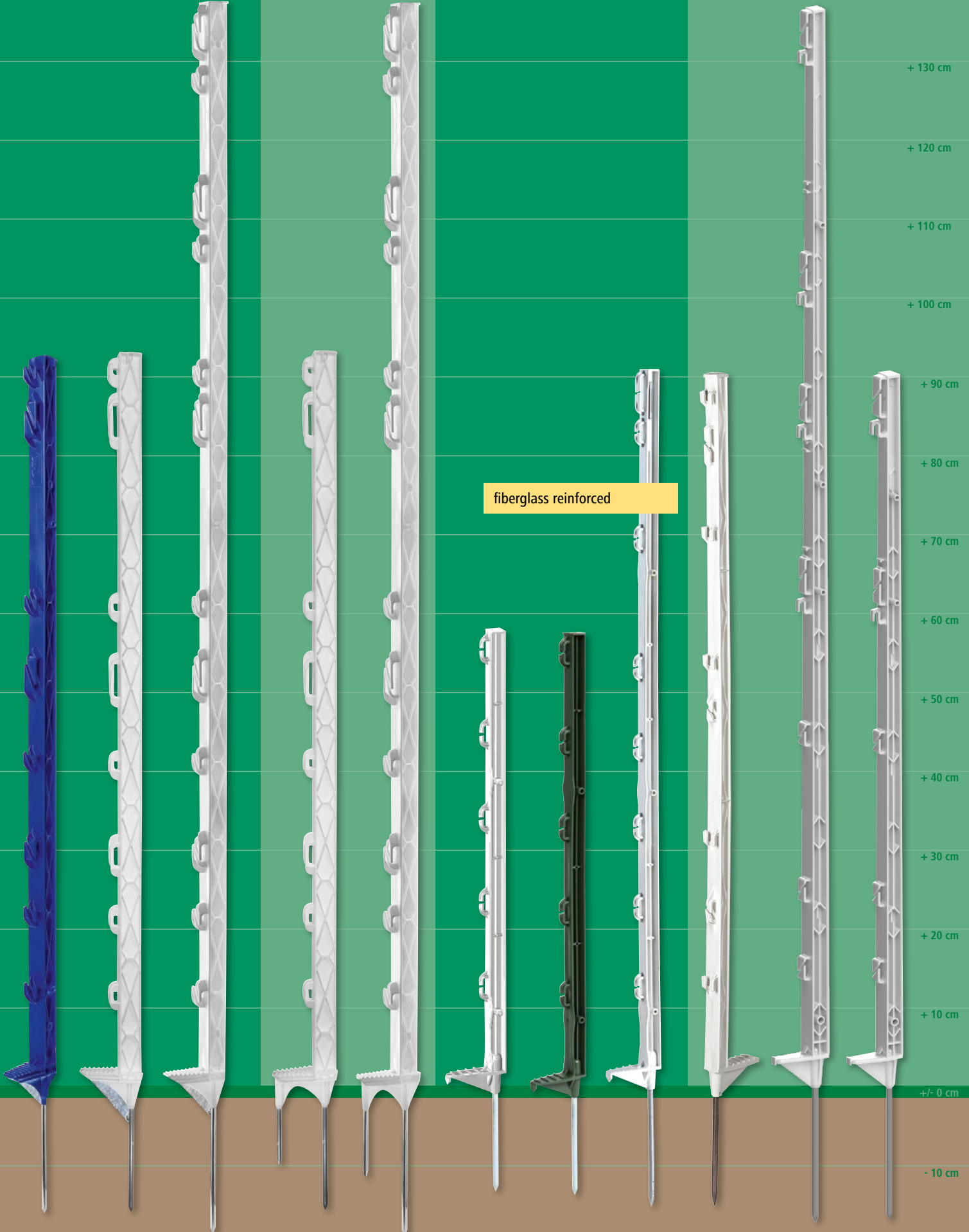



fiberglass reinforced

4418083 441808 441809 441806 441807 441810 4418102 441812 44497 443412 443413 -20 cm

Plastic Posts

Classic Plastic Posts with Double Step-in

- for all conventional tapes, polywires, ropes and wires
- vertically reinforced for increased stability
- with galvanized spike

ref. no.	colour	total height	spike					€
44491	white	105 cm	17 cm	5 x rope, 2 x 20 mm tape, 1 x 40 mm tape	5	-	500	
443492	white	125 cm	21 cm	3 x rope, 3 x 20 mm tape, 3 x 40 mm tape	5	20	500	
443493	white	156 cm	21 cm	4 x rope, 3 x 20 mm tape, 4 x 40 mm tape	5	20	500	
4434932	green	156 cm	21 cm	4 x rope, 3 x 20 mm tape, 4 x 40 mm tape	5	20	500	

Plastic Post Titan



with double step

- highly impact-resistant, high-grade plastic, virtually unbreakable
- also suited for sub-zero temperatures
- for all common tapes, ropes, stranded or solid wires
- high stability through additional longitudinal struts
- with galvanised earth pen





with special honeycomb structure

3 years UV warranty

ref. no.	colour	total height	spike	eyes			€
441800	white	110 cm	18 cm	5 x Rope + 3 x Tape	5	350	
441801	white	157 cm	21 cm	7 x Rope + 5 x Tape	5	500	

Plastic Post with Stirrup Step

- the post is very easily driven into the ground because the stirrup is positioned directly above the spike
- for all common tapes, ropes and polywires
- white or green
- with galvanized spike

ref. no.	colour	total height	spike	eyes				€
44417	green	114.5 cm	19 cm	1 x stranded wire, 2 x rope, 4 x 20 mm tape, 2 x 40 mm tape (incl. top insulator)	5	-	390	
44418	green	158 cm	19 cm	4 x rope, 4 x 20 mm tape, 4 x 40 mm tape	5	20	360	
444170	white	114.5 cm	19 cm	1 x stranded wire, 2 x rope, 4 x 20 mm tape, 2 x 40 mm tape (incl. top insulator)	5	-	390	
444180	white	158 cm	19 cm	4 x rope, 4 x 20 mm tape, 4 x 40 mm tape	5	20	360	

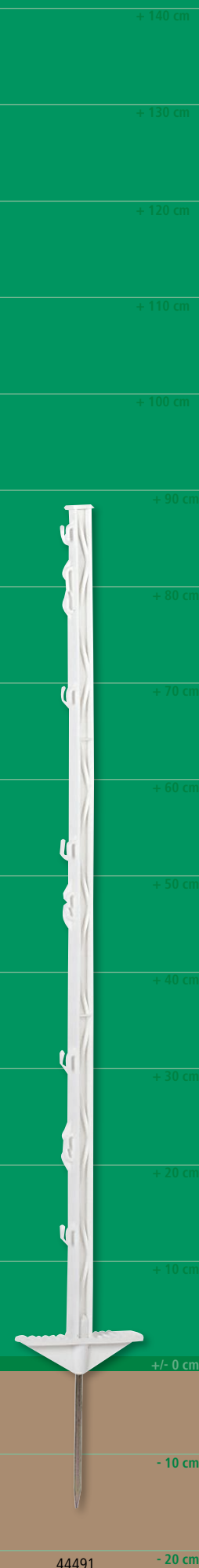

Plastic Posts

Classic

Titan

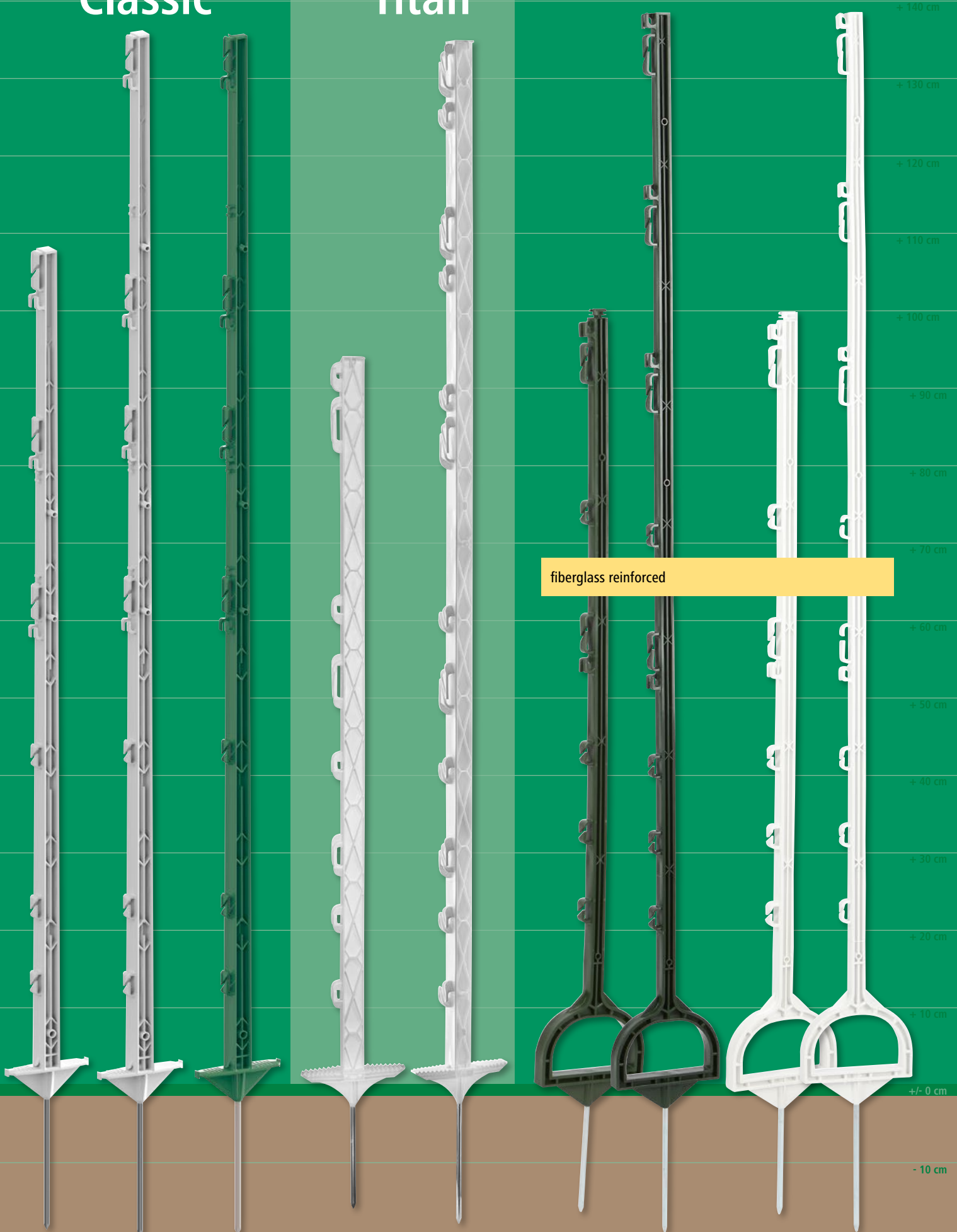

44492

44493

444932

441800

441801

44417

44418

444170

444180

- 20 cm









Recycling Posts

Recycling Post

- very durable
- ideal for working on (screwing, nailing, sawing, drilling)
- fully insulated
- pointed on one side
- drive into the ground about 50 – 60 cm deep



Ideal as a track post

ref. no.	total height	thickness			€	
44460	130 cm	45 mm	1	300		
44462	150 cm	50 mm	1	300		
44465	180 cm	75 mm	1	60		
44474	185 cm	60 mm	1	250		
44467	200 cm	75 mm	1	60		
44469	220 cm	100 mm	1	33		





Cross-profile recycling post

- well suited for soft, moist or deep grounds
- very stable cross profile 70 x 70 mm
- extremely durable
- optimal processing possible (screwing, nailing, sawing, drilling)
- fully insulated
- sharpened on one side
- ground water-neutral and rot-proof

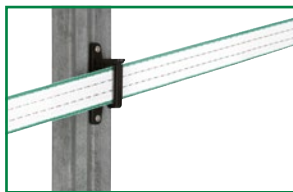
New!

Ideal as a track post



ref. no.	total height			€	
442059	150 cm	1	120		
442043	200 cm	1	120		

+ 200 cm

+ 175 cm

+ 150 cm

+ 135 cm

+ 120 cm

+ 105 cm

+ 90 cm

+ 75 cm

+ 60 cm

+ 45 cm

+ 30 cm

+ 15 cm

+ / - 0 cm

- 15 cm

- 30 cm

- 45 cm

- 60 cm

10 years warranty

44469

442043



442059

Metal Posts

Angular Steel Post

The angled steel posts are suitable for all-year-round use. There is no danger of breaking, even at the lowest temperatures.



- excellent for dry and rocky areas

ref. no.	total height	thickness				€
44421	115 cm	2 mm	4 x	10	500	
444213	115 cm	3 mm	4 x	10	500	
44453	165 cm	3 mm	5 x	10	500	

Angle Post Insulator

- made of polypropylene
- durable
- incl. metal pin





ref. no.				€
44408	25	500	-	
44408/1007	-	-	100	

Multi Post for use at Corners and Gates

- The perfect solution for use with corner and gate systems for mobile fencing (plastic, metal)
- suitable as a holder for reels



ref. no.	description			€
44297	Multi Post 120 cm, for 3 reels max.	1	50	
44299	Multi Post 165 cm, for 4 reels max.	1	50	

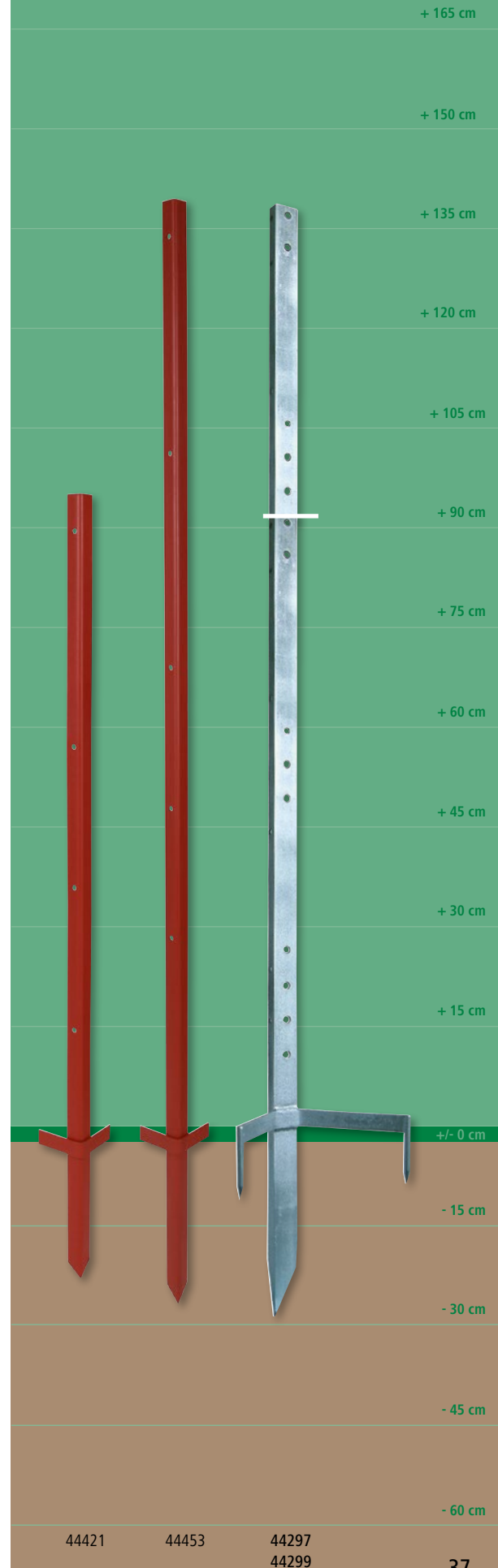

44421

44453

44297
44299

Metal Posts

+ 140 cm
+ 130 cm
+ 120 cm
+ 110 cm
+ 100 cm
+ 90 cm
+ 80 cm
+ 70 cm
+ 60 cm
+ 50 cm
+ 40 cm
+ 30 cm
+ 20 cm
+ 10 cm
+/- 0 cm
- 10 cm
- 20 cm

Posts for the cattle husbandry, proven for decades

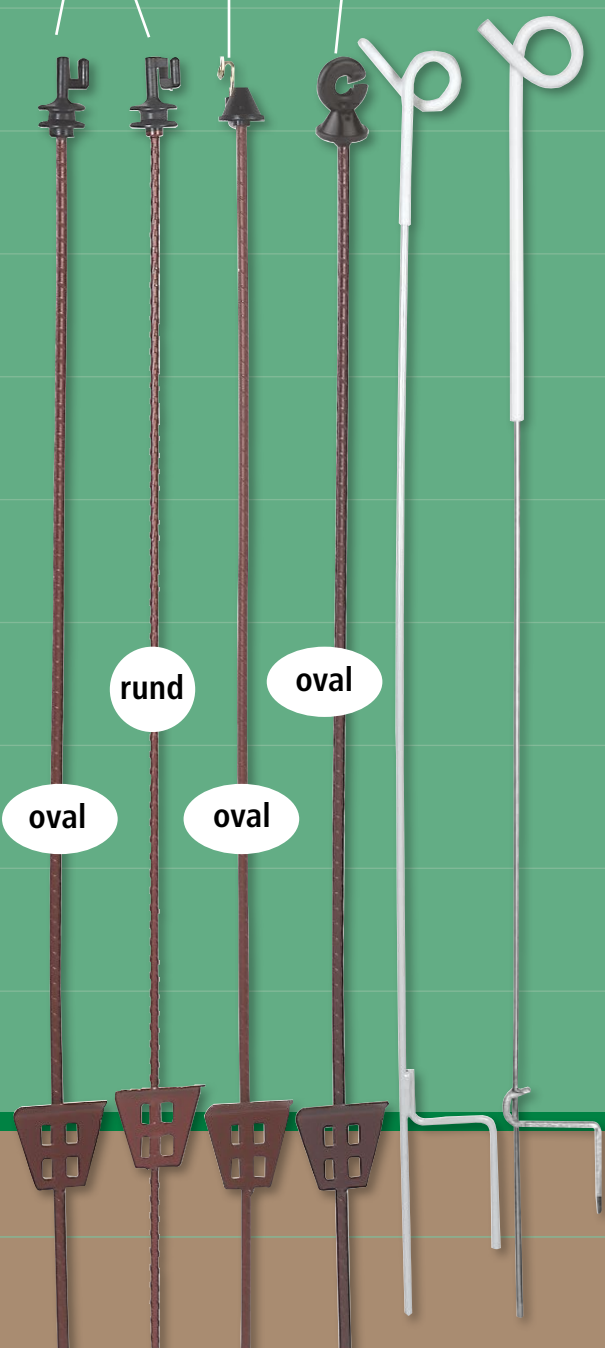

oval

rund

oval

oval

441457 441458 441455 441456 441474

Round Steel Post and Oval Steel Post

- made of spring steel
- with large top insulator
- heavy-duty tread-in
- about 20 cm spike
- colour red

ref. no.	total height	description	thickness				€
441457	107 cm	oval	11 x 5 mm	10	30	720	
441458	107 cm	round	Ø 8 mm	10	30	720	
441455	106 cm	oval	11 x 5 mm	10	30	720	
441456	106 cm	oval	11 x 5 mm	10	30	720	



ref. no.	use			€
441315	Spare Insulator Clip oval	25	400	
441316	Spare Insulator Clip round	25	400	
441317	Spare Top Insulator oval	25	500	
441318	Spare Top Insulator round	25	500	
44432	Spare Top Insulator oval with eye	25	500	
44433	Spare Ring Insulator oval	25	500	

Pigtail Post

- white post with eye
- total height 105 cm
- with approx. 15 cm double prong
- thickness of material Ø 7 mm

ref. no.	total height			€
44456	105 cm	10	1,000	

Spring Steel Post with Eyelets

- galvanised post with eyelet
- total height 109 cm
- with approx. 17 cm double prong
- material thickness 6.5 mm





ref. no.	total height			€
441474	109 cm	10	1,000	

Fencing Accessories

Cut-Out Switch

- practical on/off and changeover switch for your fence system
- ideal also for mains operated fence lines
- switches two separate fence systems

ref. no.			€
44607	1	1/20	
44607/016	1	1	

4 possible settings:

- I only fence 1
- II only fence 2
- I + II fence 1 + 2 together
- 0 Off



Lightning Choke

- protect your electric fence unit against overvoltage that can be caused by lightning strikes to the fence system

ref. no.		€
44601	1/10	



Lightning Protection

- protect your electric fence unit from over-voltage caused by lightning strikes to the fence
- for mounting on a fence post
- the 'lightning protection' takes the over-voltage from the fence directly into the ground through a fixed spark gap

ref. no.		€
449602	1/20	

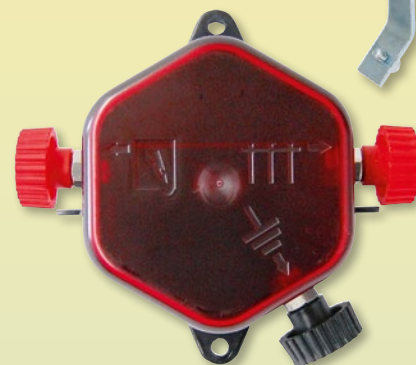

Warning Sign – Keep off the pasture!

- made of durable plastic
- dimensions: 200 x 120 mm



ref. no.		€
44628	1/25/500	

Warning sign - Caution bull in field!

- made of robust plastic
- dimensions: 200 x 120 mm
- printed on both sides

New!



ref. no.		€
446510	1	

Warning Sign – Caution Electric Fence!

- made of stable grade plastic
- dimensions: 200 x 100 mm
- double-sided printed



ref. no.		€
44620	1/10/500	

Warning Sign – Do not feed the animals!

- made of durable plastic
- dimensions: 200 x 120 mm



ref. no.		€
44621	1/25/500	

STAR Line

STAR



STAR product line was developed for the high demands of modern animal husbandry. High-quality materials guarantee outstanding functionality and consistently high levels of security!

reinforced outer edges =
high tear resistance

wire grouping =
permanent re-electrification

STAR Fencing Tapes

- the conductivity associated with thick, tin-plated copper conductors and strong stainless steel conductors is 40 times higher than that achieved with conventional conductive materials
- reinforced outer edges - strong polyethylene strands increase tear resistance
- wire grouping - there is a link of two live wires to keep the fence voltage at a constant level
- in order to prevent corrosion always use tape accessories (connectors, gate insulators, gate handles etc.) made of stainless steel

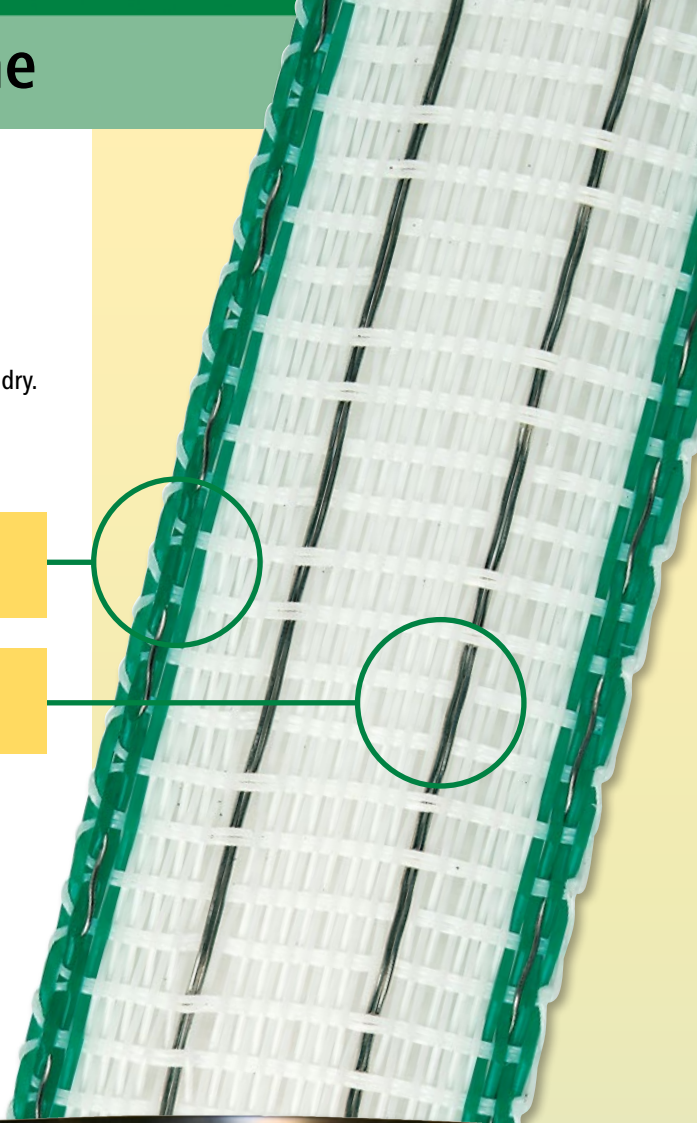

ref. no.	length	width	colour	recommended fence length max.	resistance Ω/m	number of conductors	stainless steel wires	copper wires tinned	breaking strength		€
441501	200 m	12 mm	white / green	5,000 m	0,21	4	3 x 0,30 mm	1 x 0,30 mm	108 kg	1/12	
441502	200 m	20 mm	white / green	10,000 m	0,10	6	4 x 0,30 mm	2 x 0,30 mm	166 kg	1/6	
441503	200 m	40 mm	white / green	18,000 m	0,05	10	6 x 0,30 mm	4 x 0,30 mm	290 kg	1/6	

STAR Line

STAR Fencing Ropes

This rope consists of some single ("mono") continuous filaments ("fil") made of polyethylen. This gives the rope a higher UV resistance and thus a longer service life.

- the conductivity associated with thick, tin-plated copper conductors and strong stainless steel conductors is 40 times higher than that achieved with conventional conductive materials
- in order to prevent corrosion always use tape accessories (connectors, gate insulators, gate handles etc.) made of stainless steel

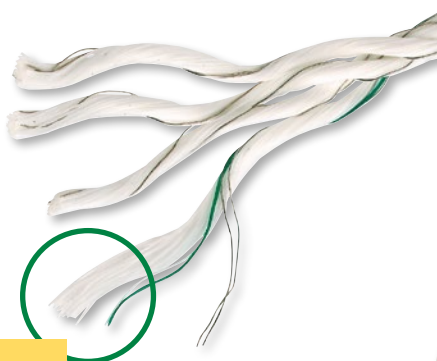

strong monofilament fibres =
higher breaking strength



ref. no.	length	Ø	colour	recommended fence length max.	resistance Ω/m	number of conductors	stainless steel wires	copper wires tinned	breaking strength		€
44538	200 m	6 mm	white / green	14,000 m	0,07	6	3 x 0,30 mm	3 x 0,30 mm	400 kg	1/6	
44537	500 m	6 mm	white / green	14,000 m	0,07	6	3 x 0,30 mm	3 x 0,30 mm	400 kg	1/2	
44539	200 m	8 mm	white / green	18,000 m	0,05	8	4 x 0,30 mm	4 x 0,30 mm	780 kg	1/2	

STAR Polywires

- strong PE threads - provide constantly high breaking strength on your fencing system
- the conductivity associated with thick, tin-plated copper conductors and strong stainless steel conductors is 40 times higher than that achieved with conventional conductive materials
- wire grouping - three linked wires respectively keep the fence voltage at a constant level
- in order to prevent corrosion always use tape accessories (connectors, gate insulators, gate handles etc.) made of stainless steel

wire grouping =
permanent re-electrification

strong PE threads =
increased breaking strength



ref. no.	length	colour	recommended fence length max.	resistance Ω/m	number of conductors	stainless steel wires	copper wires tinned	breaking strength		€
44528	400 m	white / green	10,000 m	0,10	6	3 x 0,20 mm	3 x 0,25 mm	77 kg	1/6	
441788	1000 m	white / green	10,000 m	0,10	6	3 x 0,20 mm	3 x 0,25 mm	77 kg	1/6	

PROFI Line



PROFI Line guarantees excellent conductivity and a very long service life for medium to long fences. The use of our new conductor material TriCOND makes tapes, polywires and ropes 5 x more conductive. That means you can operate fences that are 5 x longer!

PROFI Fencing Tapes



- very good conductivity
- good visibility
- available in different widths
- high quality workmanship
- excellent value for money

TriCOND = 5 x higher conductivity than stainless steel conductors

strong monofilament fibres
= higher breaking strength

new conductors TriCOND =
excellent conductivity and a
long service life



ref. no.	length	width	colour	recommended fence length max.	resistance Ω/m	number of conductors	TriCOND	breaking strength			€
59500	200 m	12 mm	white /red	4,000 m	0.47	4	0.30 mm	90 kg	1/12	240	
59501	200 m	20 mm	white /red	6,000 m	0.31	6	0.30 mm	120 kg	1/12	120	
59502	200 m	40 mm	white /red	10,000 m	0.17	11	0.30 mm	230 kg	1/6	48	

PROFI Line

PROFI Fencing Ropes

- very good conductivity
- good visibility
- available in different lengths
- high quality workmanship
- excellent value for money



TriCOND = 5 x higher conductivity than stainless steel conductors

strong monofilament fibres = higher breaking strength

new conductors TriCOND = excellent conductivity and a long service life

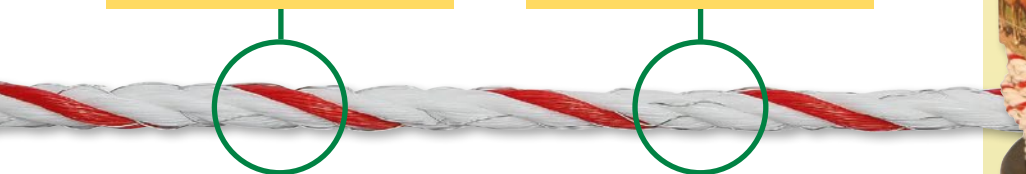

ref. no.	length	Ø	colour	recommended fence length max.	resistance Ω/m	number of conductors	TriCOND	breaking strength			€
59508	200 m	6 mm	white /red	3,000 m	0.62	3	0.30 mm	350 kg	1	96	
59509	200 m	6 mm	white /red	6,000 m	0.31	6	0.30 mm	350 kg	1	96	
59510	500 m	6 mm	white /red	6,000 m	0.31	6	0.30 mm	350 kg	1	45	

PROFI Poly Wires

- very good conductivity
- higher breaking strength
- available in different lengths
- high quality workmanship
- excellent value for money



TriCOND = 5 x higher conductivity than stainless steel conductors

strong monofilament fibres = higher breaking strength

new conductors TriCOND = excellent conductivity and a long service life

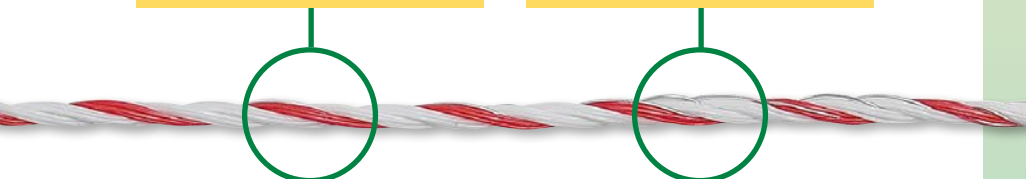

ref. no.	length	colour	recommended fence length max.	resistance Ω/m	number of conductors	TriCOND	breaking strength			€
59511	200 m	white/red	6,000 m	0.31	6	0.30 mm	100 kg	1/12	360	
59512	400 m	white/red	6,000 m	0.31	6	0.30 mm	100 kg	1/12	144	
59506	400 m	white/red	9,500 m	0.21	9	0.30 mm	100 kg	1/6	144	

CLASSIC Line



PCB materials in the CLASSIC line use reinforced stainless steel conductors to ensure excellent conductivity and superlative durability. Particularly suitable for medium-sized fence installations!

strong monofilament fibres = higher breaking strength

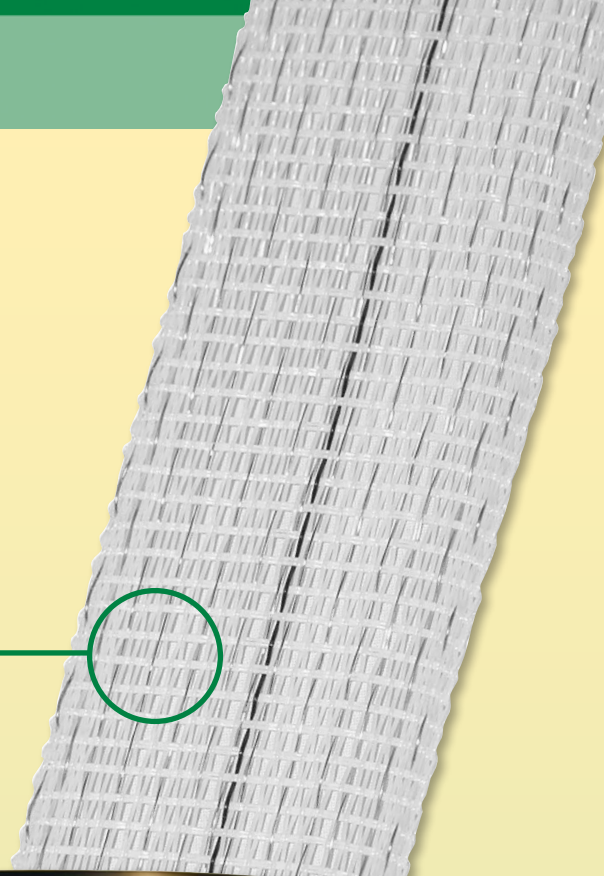

CLASSIC Fencing Tape

- reinforced stainless steel conductor = excellent conductivity and superlative durability
- strong monofilaments = increased breaking strength
- fine workmanship
- very visible for horses
- available in different widths



ref. no.	length	width	colour	recommended fence length max.	resistance Ω/m	number of conductors	stainless steel wires	breaking strength			€
449103	200 m	10 mm	white	600 m	3.58	4	2 x 0.20 mm + 2 x 0.30 mm	90 kg	1/12	240	
59507	500 m	10 mm	white	600 m	3.58	4	2 x 0.20 mm + 2 x 0.30 mm	90 kg	1/6	120	
449101	200 m	20 mm	white	800 m	2.56	6	4 x 0.20 mm + 2 x 0.30 mm	120 kg	1/12	96	
449102	200 m	40 mm	white	1,600 m	1.21	13	9 x 0.20 mm + 4 x 0.30 mm	230 kg	1/6	48	

CLASSIC Line

CLASSIC Ropes

- reinforced stainless steel conductor = excellent conductivity and superlative durability
- consists of several single („mono“) continuous filaments (“fil“) of polyethylene. By this UV resistance and breaking strength rises and thus durability increases.
- fine workmanship
- very visible for horses
- good value for money



Reinforced stainless steel conductor = excellent conductivity and superlative durability



ref. no.	length	Ø	colour	recommended fence length max.	resistance Ω/m	number of conductors	stainless steel wires	breaking strength			€
449110	200 m	6 mm	white	1,600 m	1.20	6	6 x 0.40 mm	400 kg	1/6	96	

CLASSIC Polywires

- strong monofilaments = increased breaking strength
- fine workmanship
- good value for money
- available in different lengths and conductivities

strong monofilament fibres = higher breaking strength



ref. no.	length	colour	recommended fence length max.	resistance Ω/m	number of conductors	stainless steel wires	breaking strength			€
449114	250 m	white	500 m	3.87	6	6 x 0.20 mm	80 kg	1/12	432	
449112	500 m	white	500 m	3.87	6	6 x 0.20 mm	80 kg	1/6	240	
449113	400 m	white	800 m	2.58	9	9 x 0.20 mm	100 kg	1/6	144	

BASIC Line

BASIC



The BASIC line features extremely durable, tried-and-tested stainless steel conductors. Particularly attractive prices for shorter fences.

BASIC Fencing Tape

- well-tried stainless steel conductors
- for shorter fence lines
- available in different colours



ref. no.	length	width	colour	recommended fence length max.	resistance Ω/m	number of conductors	stainless steel wires	breaking strength			€
441520	200 m	10 mm	white	200 m	11.0	4	4 x 0,16 mm	60 kg	1/12	240	
441521	200 m	20 mm	white	200 m	11.0	4	4 x 0.16 mm	90 kg	1/12	240	
441522	200 m	40 mm	white	400 m	5.50	8	8 x 0.16 mm	130 kg	1/6	96	
441523	250 m	10 mm	yellow / orange	200 m	11.0	4	4 x 0.16 mm	60 kg	1/12	240	
441524	200 m	20 mm	yellow / orange	200 m	11.0	4	4 x 0.16 mm	90 kg	1/12	240	
441526	200 m	10 mm	orange	200 m	11.0	4	4 x 0.16 mm	60 kg	1/12	240	
441527	200 m	20 mm	orange	300 m	7.34	6	6 x 0.16 mm	90 kg	1/12	240	
441529	200 m	40 mm	orange	550 m	3.67	12	12 x 0.16 mm	130 kg	1/6	96	

BASIC Line

BASIC Fencing Ropes

- for shorter fence lines

441508: polypropylene

441500: weatherproof polyethylene



ref. no.	length	Ø	colour	recommended fence length max.	resistance Ω/m	number of conductors	iron wire tinned	stainless steel wires	breaking strength			€
441508	200 m	6 mm	white	3,000 m	0.35	2	2 x 0.50 mm	-	350 kg	1/6	96	
441500	200 m	6 mm	white	500 m	3.87	6	-	6 x 0.20 mm	350 kg	1/6	96	

BASIC Polywires

- well-ried stainless stell conductors
- for shorter fence lines



ref. no.	length	colour	recommended fence length max.	resistance Ω/m	number of conductors	stainless steel wires	breaking strength			€
44521	250 m	yellow / orange	250 m	7.74	3	3 x 0.20 mm	90 kg	1/12	288	
44833	1000 m	yellow / orange	250 m	7.74	3	3 x 0.20 mm	90 kg	1/6	72	
441595	250 m	orange	150 m	13.78	3	3 x 0.16 mm	60 kg	1/20	420	
441596	500 m	orange	150 m	13.78	3	3 x 0.16 mm	60 kg	1/12	288	
441597	250 m	white	150 m	13.78	3	3 x 0.16 mm	60 kg	1/20	420	
441598	500 m	white	150 m	13.78	3	3 x 0.16 mm	60 kg	1/12	288	

Polywires

EconomyLine Mono Wire

- 2 galvanised steel wires of 0.50 mm wrapped around 1 nylon core of 1.40 mm
- excellent conductivity
- 3 years UV warranty



ref. no.	length	colour	recommended fence length max.	resistance Ω/m	number of conductors	iron wire	breaking strength			€
44502	500 m	transparent	3,000 m	0.35	2	0.50 mm FeZn	45 kg	1/8	192	
44503	1000 m	transparent	3,000 m	0.35	2	0.50 mm FeZn	45 kg	1/4	120	

Fencing Wire Aluminium

- excellent conductivity, 4 times higher than conventional steel wire
- easy to handle during installation
- low weight (by 2/3 less than steel wire)

ref. no.	length	∅	resistance Ω/m	breaking strength				€
445002	400 m	1,6 mm	0,020	60 kg	1	4	168	
445007	400 m	1,8 mm	0,015	75 kg	1	4	144	
445003	400 m	2,0 mm	0,010	90 kg	1	4	120	



Stranded Wire galvanized

- 7 strands • very flexible, easy to install • multi-use, e.g. for wildlife control





ref. no.	length	description	∅	resistance Ω/m	breaking strength			€
44500	200 m	Stranded Wire without Reel	1,2 mm	0,120	200 kg	1	400	
445009	1000 m	Stranded Wire on Reel	1,5 mm	0,120	200 kg	1	80	

Electric Wires

Steel Wire galvanized

- very good conductivity
- proven in fence construction for decades
- optimum current output upon animal contact





ref. no.	length	Ø	resistance Ω/m	breaking strength			€
445041	322 m	1,6 mm	0,070	95 kg	1/5	150	
44504	250 m	1,8 mm	0,050	110 kg	1/5	100	

High-Tensile Steel Wire for Permanent Fence

- zinc/aluminium alloy for long lasting protection
- ninefold protection against corrosion compared to galvanized wire
- extremely good conductivity
- ideal for permanent fence installations
- optimum current output upon animal contact



ref. no.	length	Ø	resistance Ω/m	breaking strength			€
445055	1000 m	2,0 mm	0,060	345 kg	1	40	
44505	625 m	2,5 mm	0,035	650 kg	1	40	

Wire Pay-Out Spinner

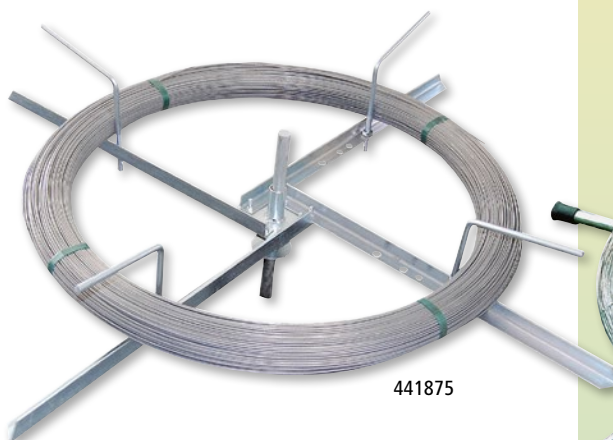

- trouble-free unrolling of permanent fencing wire
- galvanized
- also for Horse Wire



441875



44279

ref. no.			€
44279	1	20	
441875	1/6	108	

Temperature Equalisation Spring

- sturdy model for 2.5 mm steel wire
- eases strain on wire and corner posts
- balances temperature variations and renders the fence flexible



ref. no.	length	Ø spring	material		€
44704	435 mm	43 mm	galvanized	1/20	
44705	435 mm	43 mm	stainless steel	1/20	
44259	200 mm	25 mm	stainless steel	1/125	
446506	500 mm	-	Protective hose for temperature equalisation springs	1/10	



44259

44705

446506

Electric Wires

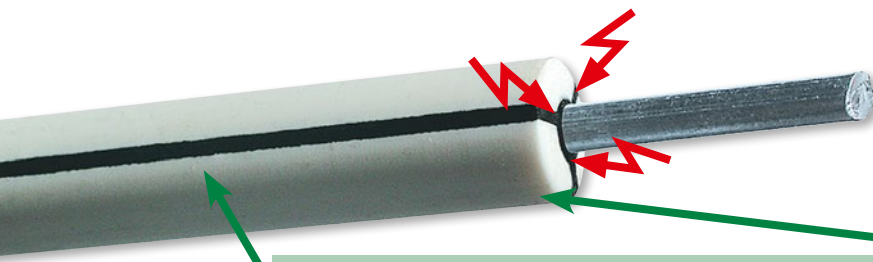

Steel Wire

Inside there is a galvanized steel wire of 2.5 mm.

Electrically conducting plastic

A coating of electrically conducting mixture of carbon fibre and plastic that reaches the surface through three lines, covers the steel wire.

Polyethylen-Polymer

A coating of white UV-stabilized polyethylene covers the area between live materials.



Premium Horse Wire

Currently the most hard-wearing electrifiable horse fencing system on the market! The Premium Horse Wire provides a very strong mechanical barrier thanks to the 2.5 mm thick steel wire. The electrically conductive white/black plastic protects the interior steel wire from the weather and resists a breaking load of up to 800 kg. Its round shape and smooth surface mean cuts from the conductor material are avoided.

- length 250 m
- Premium Horse Wire 8 mm exterior diameter
- great conductivity 0.035 Ohm/m
- high mechanical barrier due to steel wire (breaking strength 800 kg)
- electrifiable and very safe
- extremely weather-proof (cold, warmth, moisture)
- high visibility due to white coating and Ø 8 mm
- UV-stabilised PE covering
- no physical hazard for horses due to round and smooth surface



ref. no.			€
44873	1	20	



Permanent Fencing

Give us a call! We'll be happy to assist you with your fence planning!

Corner Sleeve Insulator

- with integrated pinlock system
- ideal for installing an outside corner with poles up to max. \varnothing 140 mm
- ideally suited for Premium Horse Wire and all common ropes, stranded wires and wires
- screw in or nail on

New!

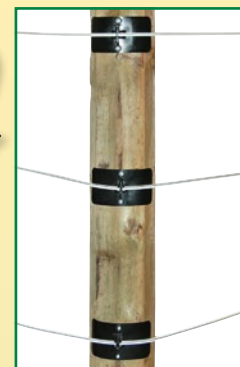

ref. no.		€
441284	1/10/240	

Tip: You can also use 2 insulators for poles with very large diameters, so as to avoid the conductor material touching the pole.

De-tensioning Set "Horizontal"

- incl. insulation
- incl. stainless steel temperature equalisation spring
- incl. gear wheel wire tensioner (clamping lever not included in delivery)
- incl. stainless steel wire rope loop for fast and easy attachment to the tension post
- suitable for Premium Horse Wire and steel wire
- for tensioning posts with a diameter of up to 160 mm

New!

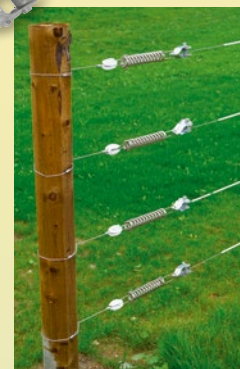

ref. no.	description		€
446509	De-tensioning Set "Horizontal"	1	
446506	Protective hose for temperature equalisation springs	1	



De-tensioning Set "Diagonal"

Set for the diagonal de-tensioning of an H pillar design in the corner and at the fence start and/or end for very high tensile forces of the conductor material e.g. Premium Horse Wire and steel wire.

- incl. protective hose
- incl. stainless steel wire rope loop
- incl. gear wheel wire tensioner (clamping lever not included in delivery)
- incl. 2 x 90° metal brackets and wood screws

ref. no.		€
446508	1	

New!

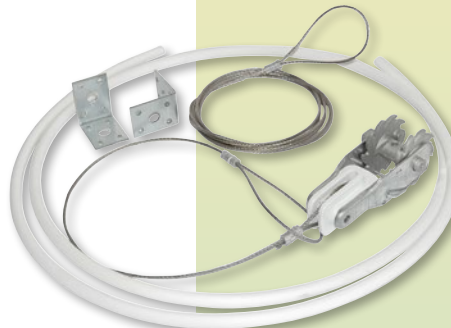

Corner Solution for Premium Horse Wire

Set of 3

- incl. stainless steel wire rope loop for fast and easy attachment to the corner post
- suitable for Premium Horse Wire, steel wire and fence rope
- for corner posts with a diameter of up to 160 mm

ref. no.		€
446507	3	

New!

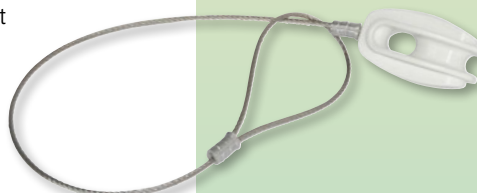



Easy Loop Plug Connector

- for easy stopping at the last post
- ideal for Premium Horse Wire

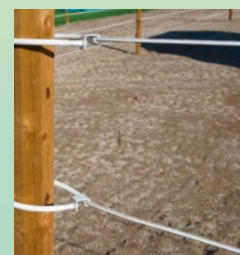
New!



ref. no.			€
446519	10	1/10/500	

Tip: we recommend the hose insulator (Art. No. 44392) for insulation at the fence post

Litzclip® Tape and Rope Connector

- simple but perfect - the tool-free tape, rope and wire connectors from Litzclip® are self-evident in their function and can be integrated very quickly and easily into new and existing fence systems.
- the connectors come in stainless steel or galvanised metal versions. They ensure continued electrification of the conductor material and can themselves withstand high tensile forces
- extremely resilient sealing caps made from plastic with UV stabiliser - no regranulate! extremely long-lasting and impact-resistant.
- sliding the sealing cap outwards ensures the safe and quick securing of the wire material.
- narrow slit width of the sealing cap guarantees optimum contact between the wire material and the connecting plate and subsequently maximum conductivity.

Litzclip® patented Quality Products "Made in Germany"



Made in Germany

Tape Connector Litzclip®

- easy connection of 2 tape ends
- the quick solution for repairing torn fence tapes
- special narrow, punched rectangular openings for the easy introduction and securing of the tape



Scan the QR code and watch the video or <http://load.kerbl.de/1epRFZK>

ref. no.	use	material		€
442000/056	12,5 mm tapes	Stainless steel (INOX)	5	
442001/056	20 mm tapes	Stainless steel (INOX)	5	
442002/056	40 mm tapes	Stainless steel (INOX)	5	
442010/056	12.5 mm tapes	galvanized	5	
442011/056	20 mm tapes	galvanized	5	
442012/056	40 mm tapes	galvanized	5	

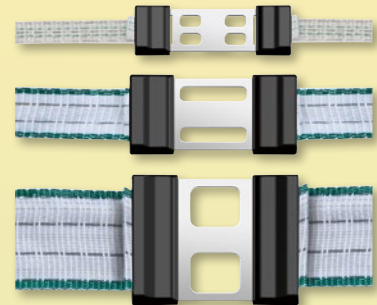

Rope Connector Litzclip®

- ideal for connecting 2 rope ends of up to 6 mm in diameter
- the quick solution too for repairing a torn fence rope
- special key-shaped punched opening for the easy introduction and secure fixing of the rope



Scan the QR code and watch the video or <http://load.kerbl.de/1ojd5Rb>

ref. no.	use	material		€
442004/056	for ropes up to Ø 6 mm	Stainless steel (INOX)	5	
442016/106	for ropes of diameter 5 mm	galvanized	10	
442017/106	for ropes of diameter 6 mm	galvanized	10	



Safety Link – Litzclip®

The ideal protection for your horse in panic situations!

This newly developed 'ROPE breaking point' made from UV-stabilised plastic opens in panic situations. This reduces injuries from tangling in the rope and/or when breaking through fences. Thanks to the replacement safety buttons, the rope ends are easy to reconnect with the two high-quality stainless steel connecting plates.

- components: 6 x Safety Link sets complete plus 6 x replacement safety buttons

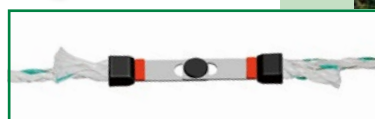
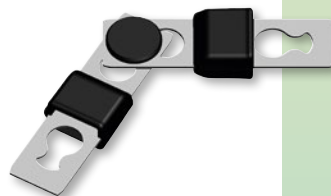

New!



Expert tip: Install the Safety Link into your rope fence system as frequently as possible to improve functionality in panic situations.

Breaking load up to 20 kg!

ref. no.	use	Material		€
442008/066	for ropes of diameter 6 mm	Stainless steel (INOX)	6	

Litzclip® Wire Connector

- ideal for connecting 2 wire ends of up to approx. 3 mm in diameter
- special key-shaped punched opening for the easy introduction and secure fixing of the wire
- extremely resilient sealing caps made from plastic for locking and pressing the wire to the metal plate in order to ensure maximum conductivity
- plastic caps made from PA plastic with UV stabiliser – no regranulate! extremely long-lasting and impact-resistant
- suitable for use with all types of wire network

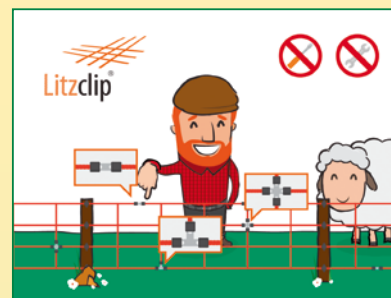

Wire Connector Litzclip®

- ideal for connecting 2 wire ends of up to approx. 3 mm in diameter
- the straightforward solution, even for repairing a torn wire
- special key-shaped punched opening for the easy introduction and secure fixing of the wire

ref. no.	use	material		€
442003/106	for polywires up to Ø 3 mm	Stainless steel (INOX)	10	
442013/106	for wires up to 3 mm in diameter	galvanized	10	

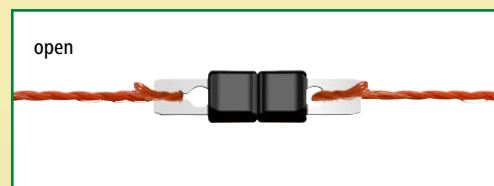

Wire Cross-Connector Litzclip®

galvanized

- suitable for use with all types of wire network

ref. no.	use		€
442014/056	for wires up to 3 mm in diameter	5	

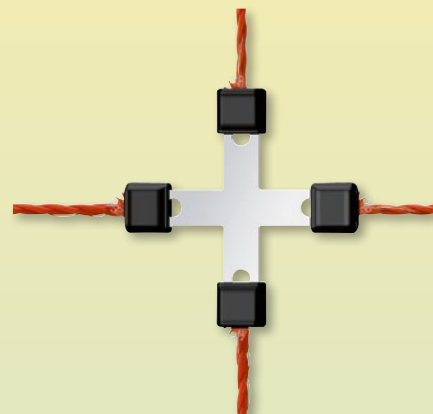

Wire T-Connector Litzclip®

galvanized

- suitable for use with all types of wire network
- for polywires up to Ø 3 mm
- 5 pieces /self-service-pack

ref. no.	use		€
442015/056	for wires up to 3 mm in diameter	5	

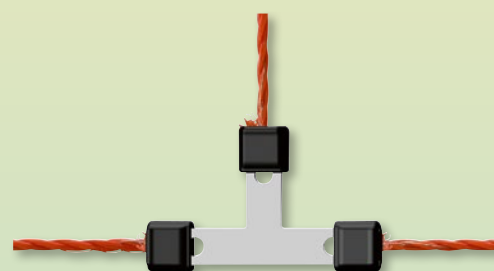

Repair kit Litzclip®

galvanized

- especially for repairing sheep, poultry and rabbit netting
- incl. 4 x straight 3 mm wire connectors
- incl. 2 x 3 mm wire cross-connectors
- incl. 2 x 3 mm wire T-connectors

ref. no.		€
442018/086	8	

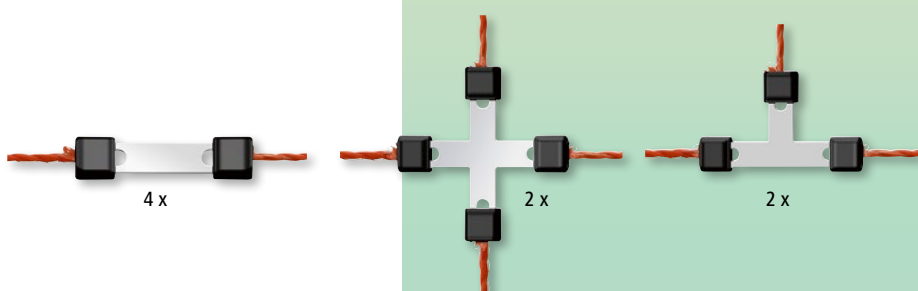



Tape / Rope / Polywire and Wire Connectors

Do not tie fencing tapes together as otherwise continuous electrification cannot be guaranteed and wires might break. To avoid this we recommend the use of our special tape connectors.





Tape Connector stainless steel

Stainless steel

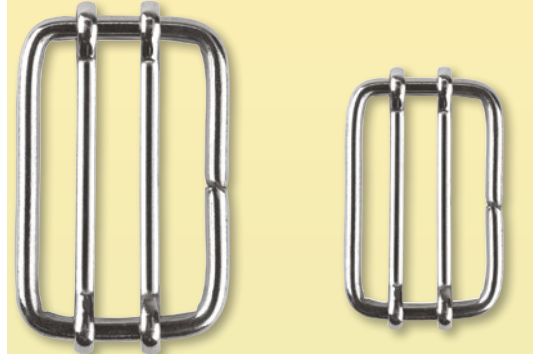
ref. no.	use			€
44594	up to 13 mm tapes	10	-	
44594/056	up to 13 mm tapes	-	5	
44595	up to 20 mm tapes	10	-	
44595/056	up to 20 mm tapes	-	5	
44596	up to 40 mm tapes	10	-	
44596/056	up to 40 mm tapes	-	5	



Tape Connector galvanized

ref. no.	use			€
44570	up to 13 mm tapes	10	-	
44570/056	up to 13 mm tapes	-	5	
44573	up to 20 mm tapes	10	-	
44573/056	up to 20 mm tapes	-	5	
44572	up to 40 mm tapes	10	-	
44572/056	up to 40 mm tapes	-	5	

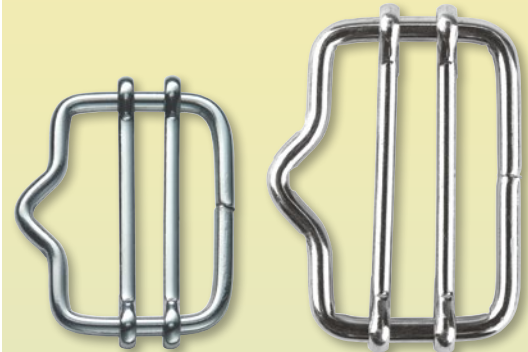

Tape Connector Plates

- the new tape connecting plate optimally connects all the electrical wires of two interconnected tapes
- the connecting plate is made of stainless steel

stainless steel



It is also suited for hooking into the gate handle

ref. no.	use		€
443457	10 - 20 mm tapes	5	
443458	40 mm tapes	5	



Quick Rope/Polywire Connector



- allows ropes, polywires and tapes of up to 10 mm to be connected to gate insulators and handles quickly and easily by hand, resulting in a connection with optimal electrical conductivity
- galvanised design

ref. no.		€
441209/046	4	





Tape / Rope / Polywire and Wire Connectors

Rope Connector stainless steel

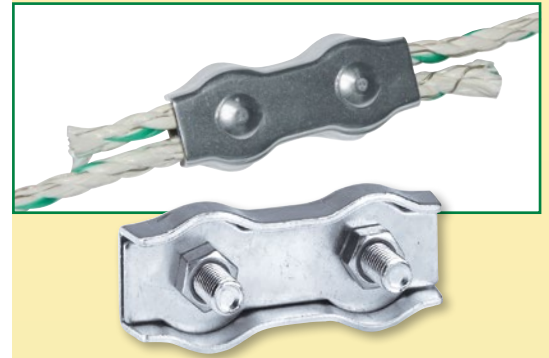
ref. no.	use			€
44540	for ropes ø 6 mm	10	-	
44540/056	for ropes ø 6 mm	-	5	
44541	for ropes ø 8 mm	10	-	
44541/056	for ropes ø 8 mm	-	5	



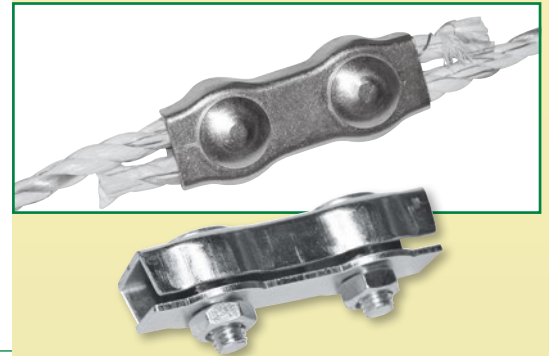

Rope Connector galvanized

ref. no.	use			€
44535	for ropes ø 6 mm	10	-	
44535/056	for ropes ø 6 mm	-	5	
44534	for ropes ø 8 mm	10	-	



Rope- and Wire Connector



- safe mechanical and electrical connection
- easy to mount with a screw driver
- galvanized

ref. no.	use			€
441561	for polywire up to ø 2.5 mm	10	-	
441561/056	for polywire up to ø 2,5 mm	-	5	
441560	for rope up to ø 6,5 mm	10	-	
441560/056	for rope up to ø 6,5 mm	-	5	



Wire connecting clamp, galvanized

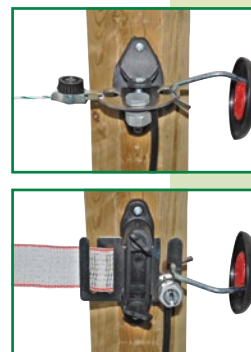

- for the safe, vertical connection of fixed fence wire series and/or the underground cable with the fence wire

ref. no.			€
441225	10	-	



Gripple Wire Connector

- the Gripple system repairs fences 6 x faster than conventional connectors

ref. no.	for wire Ø	operation load				€
44707	1,00 - 2,00 mm	220 kg	-	20	300	
44706	2,00 - 3,25 mm	400 kg	-	20	200	
44706/066	2,00 - 3,25 mm	400 kg	6	-	-	
44703	Tension Tool	-	-	1	4	



Reels

Super Big Reel

- extra-wide design
- suitable for approximately 1,200 m tape (10 mm) and 1,000 m rope (6 mm) or 2,000 m wire (3 mm)
- locking brake prevents drum from accidentally reeling on

New!



442705

ref. no.	description			€
441270	Super BIG reel	1	36	
441271	Spare reel for Super BIG	1	48	
441272	Stand for Super BIG reel	1	-	
442705	Easy Drill Roll-up Adapter	1/20	-	

Plastic Reel Super

- very hardwearing plastic reel (replaceable)
- suitable for approximately 600 m wide tape (10 mm) and 500 m rope (6 mm) or 1,000 m wire (3 mm)
- locking pin prevents reel from accidental reeling on
- the ideal aid for fence building



New!



442705

ref. no.	description			€
44270	Reel complete	1	50	
44271	Spare reel	1	60	
44272	Stand only	1	250	
442705	Easy Drill Roll-up Adapter	1	-	

Euro Reel

- new with metal hook (441041)
- metal hook allows fast electrification of the conductor material on the reel!
- suitable for approximately 200 m wide tape (10 mm) and 200 m rope (6 mm) or 400-500 m wire (3 mm)
- reel Ø 180 mm

New!

ref. no.	description			€
441040	Euro Reel Eco	1/5	200	
441041	Euro Reel with metal hooks	1/5	200	
441201	spare reel for Euro reel	1/10	200	

Euro Reel Big

- reel Ø 240 mm
- new with metal hook (441042)
- metal hook allows fast electrification of the conductor material on the reel!
- suitable for approximately 400 m wide tape (10 mm) and 300-400 m rope (6 mm) or 700-800 m wire (3 mm)

New!

ref. no.	description			€
441042	Euro Reel Big with metal hooks	1/5	150	
441206	spare reel for Euro Reel Big	1/10	120	



Locking pin

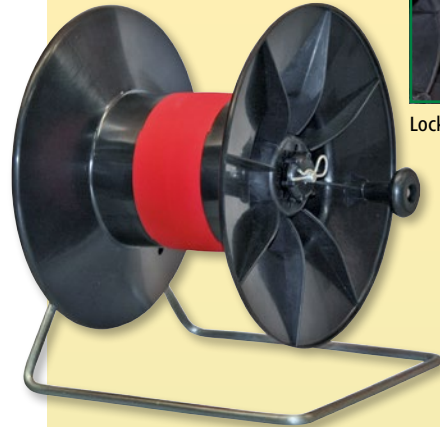

Locking pin



441040

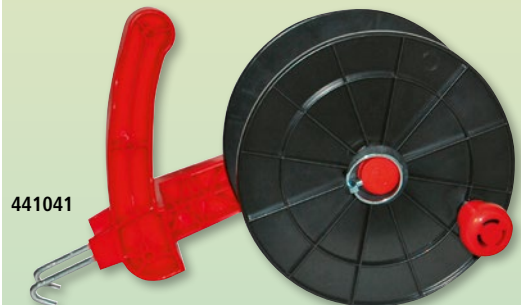

441041





The Porta Reel System for Temporary Fencing



A perfect professional reel system for temporary fencing systems that have to be assembled and disassembled quickly and for many years of use. The indispensable aid for modern fencing.

Multi Post

- the ideal solution for corner and gate systems for mobile fencing (plastic, metal)

ref. no.	description			€
44297	Multi Post 120 cm, for 3 reels max.	1	50	
44299	Multi Post 165 cm, for 4 reels max.	1	50	



ref. no.	description			€
44350	Corner and fence line insulator PROFI	10	200	
441241	Gate Handle Insulator	10	250	
44324	Ring Insulator	25	500	

Geared Reel 3 : 1

- save time by 3-way transmission
- special eye for well-directed wire routing
- impact-proof plastic guarantees durable use
- heavy-duty steel crank arm
- up to 600 m plastic polywire or about 200 m tape

NEW – now with reliable fixative locknut!

ref. no.		€
44280	1	

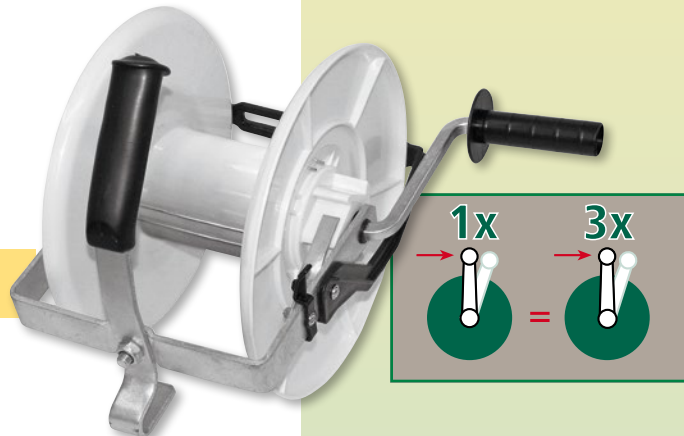

Compact Reel

- impact-proof plastic guarantees durable use
- special eye for well-directed wire routing
- heavy-duty steel crank arm
- galvanized carry handle for manual use or for clipping into the portable reel system
- with locking ratchet
- up to 600 m plastic polywire or about 200 m tape

ref. no.		€
44296	1	

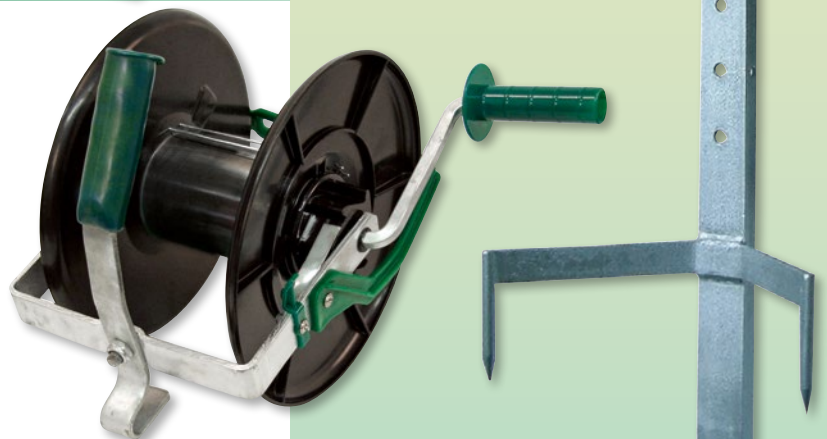

Mounting Bracket

- attaches reel

ref. no.		€
44298	1/50	

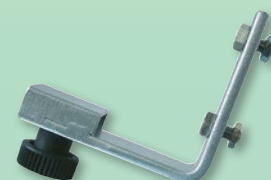
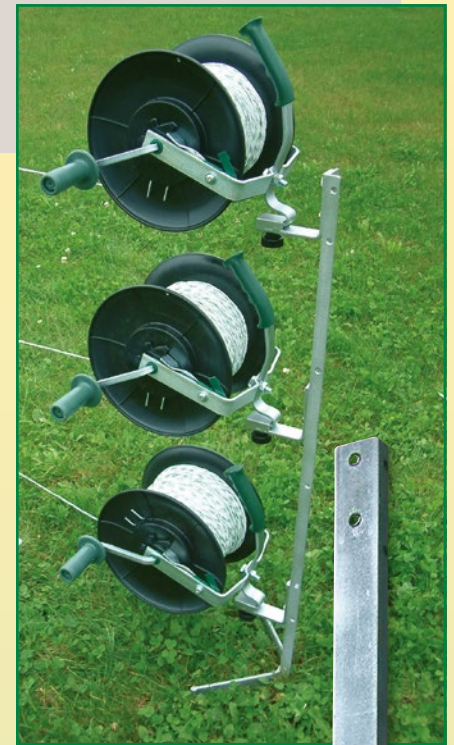

Ring Insulators with Short Support

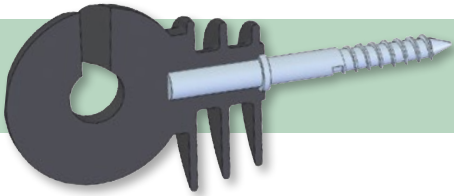

The insulators with excellent insulation characteristics



Easy Drill Ring Insulator EDX

with short support

- with short 6 mm support and new self-cutting thread
- twice as easy to screw in as standard supports; the wood is "cut" not "displaced"
- no need for pre-drilling for hard wood
- far less fracturing in wood when screwed in
- best possible insulation properties
- made from impact resistant plastic

ref. no.	colour			€
443169	black	25	500	

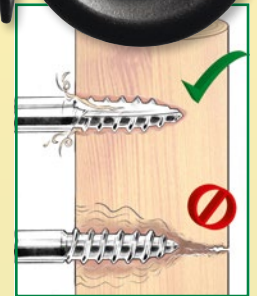

Premium Combo Insulator

with short support

- unites four different conductive material applications in ONE insulator
- 6 mm metal support
- excellent insulation due to large, wide drip-zones, which emphasise the high quality of this new insulator

ref. no.	colour			€
441380	black	25	500	



it has proven its worth more than a hundred thousand times



Ring Insulator Super Big

with short support

- galvanized 6 mm support
- for solid/stranded wire, rope and 10 mm tape
- with wide slit for rope

ref. no.	colour					€
441385	black	25	-	500	-	

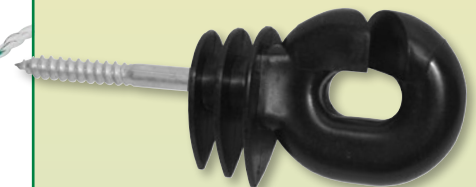
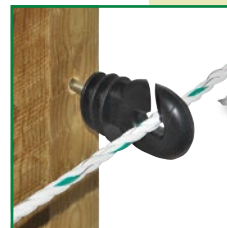

BIG Ring Insulator

with short support

- galvanized 6 mm support
- perfect insulation with 3 distance rings
- impact-resistant plastic

ref. no.	colour			€
44327	black	25	500	

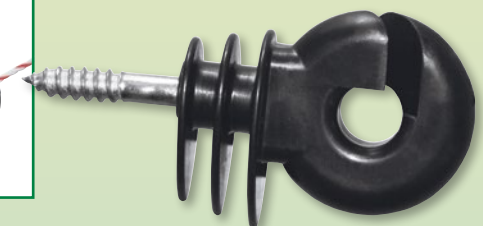
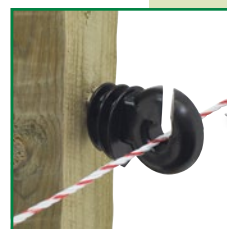

Ring Insulator compact

with short support

- galvanised 6 mm support • wide wire run

ref. no.	colour			€
44316	black	25	500	

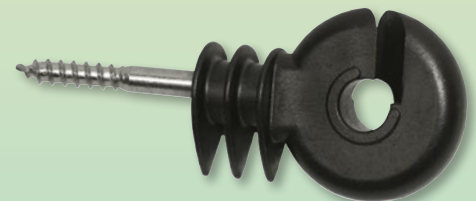

Ring Insulator

with short support

- galvanised 5 mm support • wide wire run

ref. no.	colour					€
44306	black	25	-	500	-	
44306/256	black	-	25	350	-	
44306/908	black	-	-	-	90	
441342	yellow	25	-	500	-	

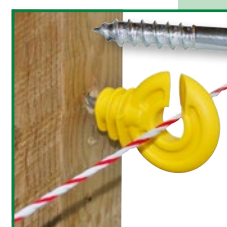

Ring Insulators with Continuous Support

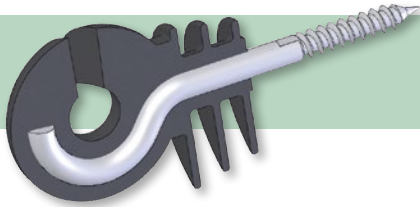

Robust insulators with metal cores



Easy Drill Ring Insulator EDX

with continuous support

- with continuous solid 6 mm support and self-cutting thread
- twice as easy to screw in as standard supports; the wood is "cut" not "displaced"
- no need for pre-drilling for hard wood
- far less fracturing in wood when screwed in
- best possible insulation properties
- impact resistant plastic

ref. no.	colour	SB	€
443269/204	black	20	

With new self-cutting thread

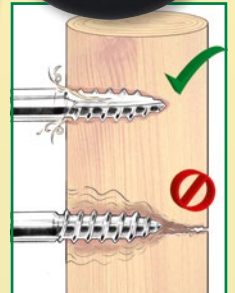

Ring Insulator BIG

- galvanised 6 mm support
- perfect insulation by 3 distance rings
- impact-resistant plastic

ref. no.	colour	bag	box	€
44326	black	25	500	

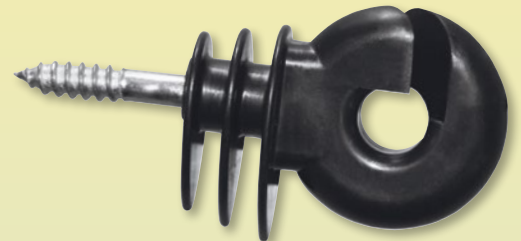

Ring Insulator compact

with continuous support

- galvanised 5.3 mm support
- wide wire run

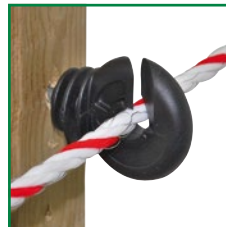

Free screwdriver!
(Ref. No. 443145/100E)

ref. no.	colour	bag	box	bucket	€
44314	black	25	500	-	
443145/100E	black	-	-	100	



Screw Bit for all Ring Insulators and Maxi-Tape Insulator

- for drills and battery screwdrivers
- easily screwed in due to its round shape
- as well as all ring insulators, also suitable for Maxi Tape Insulator 441390 and Allgäu 441381



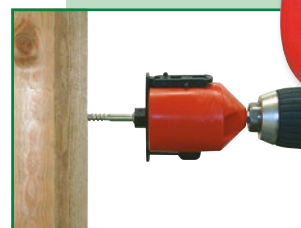

ref. no.	SB	€
441363/016	1	



Rope Insulators/Wire Insulators

Rope Insulator Euro

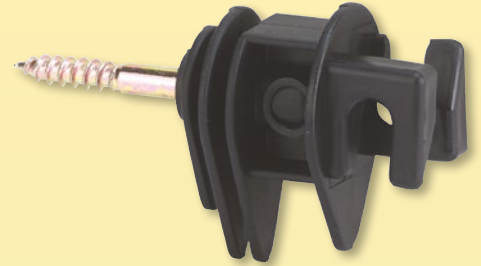

- for electric rope up to max. \varnothing 8 mm
- screws on wood
- galvanised 6 mm support

ref. no.					€
44382	25	-	500	-	
44382/304	-	30	360	-	
44382/607	-	-	-	60	



Rope Insulator Euro Cord

- heavy-duty insulator made of break-proof plastic
- screw in or nail on
- 10 years warranty for UV resistance

ref. no.				€
441396	10	-	200	







10 years UV warranty

**EURO
Cord**

PinLock Rope Insulator

- heavy-duty insulator
- ideal for all ropes up to \varnothing 8 mm polywires and steel wires



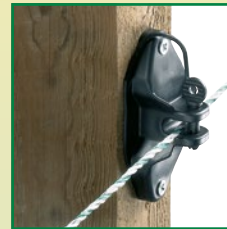

ref. no.					€
441495	25	-	500	-	

Pinlock



Permanent Fencing Insulator Highland

- black
- professional insulator for permanent fencing
- nail-on or screw-in insulator
- ideal for steel wires

ref. no.					€
441398	10	-	200	-	

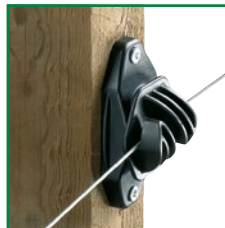



10 years UV warranty

Slit Insulators

- excellent insulation qualities
- galvanized support
- screws on wood
- for polywire and wire

Polycarbonate = highly break-proof and durable!



ref. no.	colour	description			€
44300	black	5,3 mm	25	500	
44305	red	5,3 mm	100	1,000	
44302	yellow	6,0 mm	25	500	

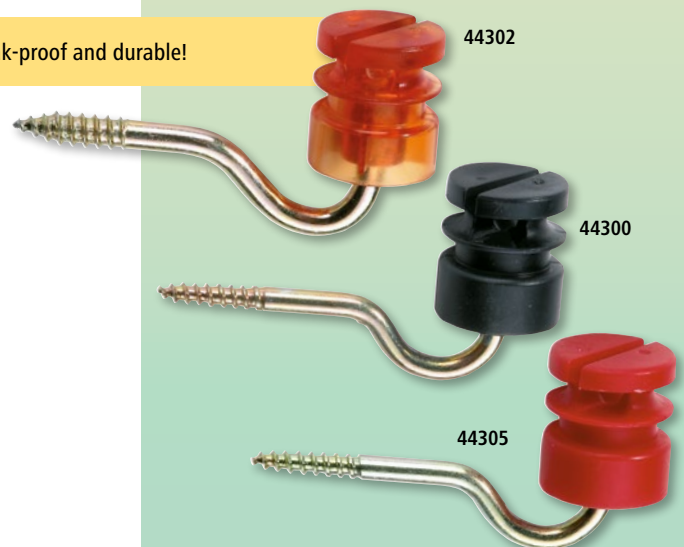

44302



44300

44305

Tape Insulators



Ring Insulator for tapes

- ideal for polytapes up to 20 mm
- with wood screw
- sturdy galvanised 6 mm support

ref. no.				€
44309	25	-	500	
44309/156	-	15	210	



Euro Tape Insulator

- for tapes up to 40 mm, wood screw
- galvanised 6 mm support
- tape easy to mount

ref. no.				€
44380	25	-	500	
44380/304	-	30	360	



Clip Insulator Maxi Tape

- galvanised 6 mm metal support
- for tapes up to 40 mm and ropes up to 6 mm
- patented

ref. no.				€
441390	25	-	500	



Premium Tape Tensioner

- for broad-bands of up to 40 mm
- for tightening
- easy tape loosening
- simple to add on to existing fence systems
- simple, secure tensioning by hand without tools - notch function

ref. no.			€
44578	10	100	

Strainer for tapes up to 40 mm

- for tapes up to 40 mm
- strains easily and safely
- for easy integration on already installed fence lines
- screw in or nail on

ref. no.			€
44577	10	100	

Our best-selling Tape Insulators for 20 mm tapes!

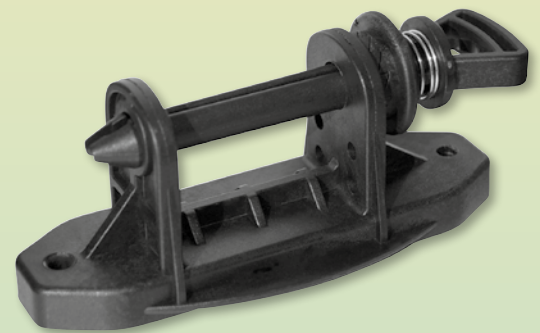
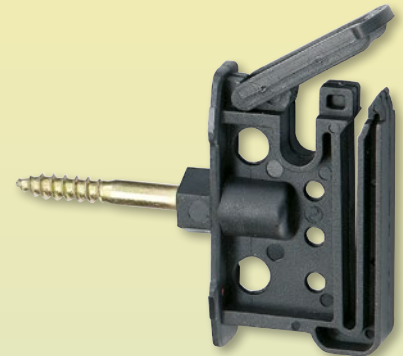
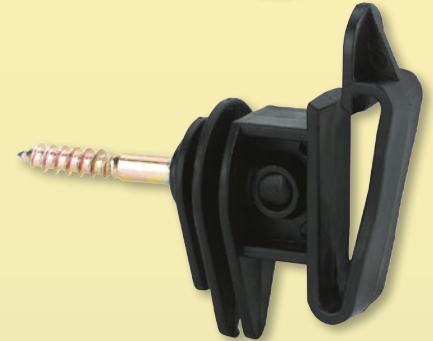
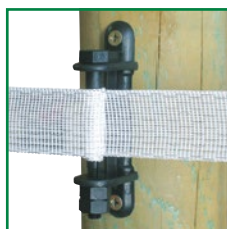
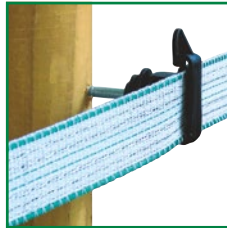

Tape Insulators

Profi Clip Insulator

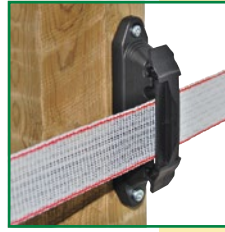

The slip-proof rubber pad holds tapes up to 40 mm eliminating tape wear and increases the service life of tapes

- UV stabilized
- screw-in or nail-on insulator
- allows fatigueless integration in already installed fence systems
- recommended as line insulator



Professional Advice: Use as Line Insulator!





ref. no.				€
44359	10	-	200	
44359/164	-	16	400	

Clip Insulator Easy Tape

- for tapes up to max. 40 mm as well as polywires up to Ø 6 mm
- ideal fence line insulator

**EASY
Tape**





ref. no.				€
441391	25	-	500	
441391/254	-	25	300	

Insulator for tapes up to 40 mm

- solid and durable type
- screw-in or nail-on insulator
- tape passes through – thus easy straining of hot tape over longer runs of fence



ideal use together with insulator 44350



ref. no.			€
44340	10	200	

Insulator for Tapes up to 20 mm

- solid and durable type
- screw-in or nail-on insulator
- tape passes through – thus easy straining of hot tape over longer runs of fence



ideal for use together with insulator 44350

ref. no.			€
44343	10	200	

Corner Insulators

Corner and Distance Insulator Profi

- electrically conductive rubber inlays through carbon fibres (patented) secure the tape very gently but reliably
- anti-slip by alternating rubber pad structure
- end or strain insulator, also excellent for corners
- mounts easily and strains tapes without fatigue

Individual interrupted / broken conductor wires are re-electrified by the electricity-conducting rubber!

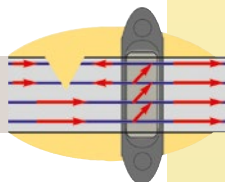

PRO TIP:
Very popular for paddock fences!

ref. no.	colour			€
44350	black	10	-	200
44350/064	black	-	6	300

Corner Insulator

- for tapes 40 - 60 mm
- screw-in or nail-on insulators

Additional brackets optional, item no. 44348

- for tapes up to 40 mm
- forks off in different directions

Important: Not suitable for tapes with copper wires!

ref. no.			€
44347	10	100	
44348	10	100	

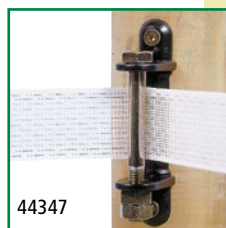

Tape Corner Insulator Cavallo

- for wide tapes of up to 40 mm
- extra strong finish, very durable
- galvanised, continuous 8 mm support for 100 % stability
- polyamide plastic for high tensile forces
- free-running tape is fed through safely thanks to smooth, rounded surface

ref. no.			€
441376	10	250	

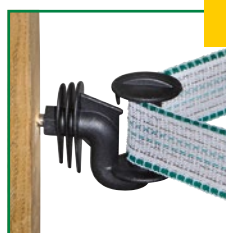

New!



Tape Corner Insulator Cavallo Metric

- for wide tapes of up to 40 mm
- extra strong finish, very durable
- galvanised, continuous 8 mm support for 100 % stability
- polyamide plastic for high tensile forces
- free-running tape is fed through safely thanks to smooth, rounded surface
- thread length: 30 mm / M6

ref. no.			€
441377	10	250	

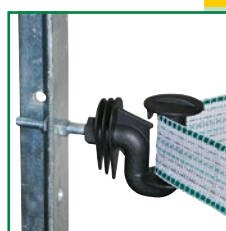

New!



Corner Insulators



Profi Gate Insulator for Tapes

Kit consists of: 4 insulators and 4 tape joiners

- solid tape insulator with stainless steel tape joiner for gate handle and fencer connection



Stainless steel



ref. no.	description				€
44355/046	Kit black	-	4	88	
443453	Spare Tape Joiner	10	-	400	

Corner Insulator Super

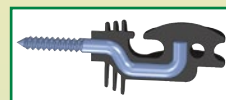
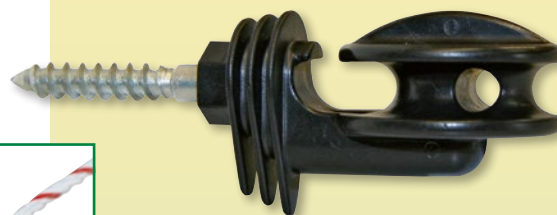
- for ropes and stranded or solid wires
- extra-strong design, highly robust
- galvanised, continuous 8 mm support for 100 % stability
- polyamide plastic for high tensile forces
- There is practically no electrical conduction, firstly because of the highly insulated supports, and secondly because of the special shape of the insulator, which prevents the conductor material from slipping onto the metal support.





The perfect corner solution

ref. no.				€
441330	10	-	250	
441330/064	-	6	-	

Corner Insulator Super with metric thread

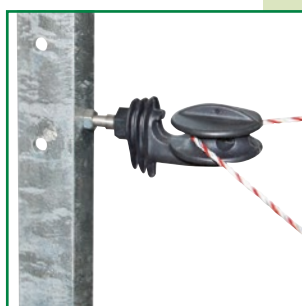
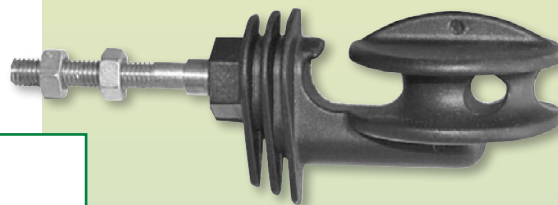
- for rope, polywire and wire
- extra strong finish, very durable
- galvanised, continuous 8 mm support
- polyamide plastic for high tensile forces
- electrical discharges effectively do not arise, partly through the highly insulated post and partly through the special form of the insulator, which prevents the conductor material slipping on the metal support.
- no slipping of the conductive material on the metal support thanks to the insulator's special shape
- thread length: 30 mm / M6





ref. no.			€
441360	10	250	

Corner Insulator for Polywires and Ropes

- with glass fibre reinforcement
- bobbin with solid 7 mm support
- swivel insulator



ref. no.			€
44330	25	250	

Corner Insulators

Porcelain Corner Insulator

- professional corner insulator made of porcelain
- high-quality
- withstands extreme tensile loads

New!

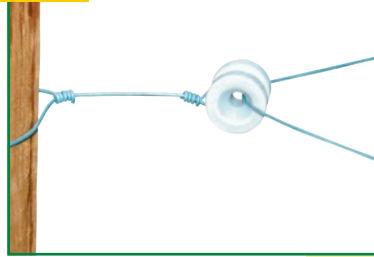



ref. no.		€
442362	10	

Strain Insulator for Ropes

- with fibreglass reinforcement
- suitable as corner and strain insulator
- important aid in fence construction





ref. no.	colour				€
44334	white	25	-	250	
44334/066	white	-	6	300	
44335	black	25	-	250	

Strain Insulator Polyamide for Steel Wire

- with fibreglass reinforcement
- suitable as corner and strain insulator in permanent fencing (plain wire)
- resists especially high strains



ref. no.				€
44358	10	250	-	

Tube Insulator

- for Horse Wire and rope up to 8 mm
- polyethylene tube as corner insulator in permanent fencing
- attaches with kramp nail (44394)
- length 60 cm



ref. no.	colour	length	Ø		€
44392	white	60 cm	8 mm	10	

Supplementary Insulators

Fastening Ring for Round Posts

- for 35 - 70 mm round posts
- incl. rubber inlay to protect the posts
- to fasten insulators with metric thread M6

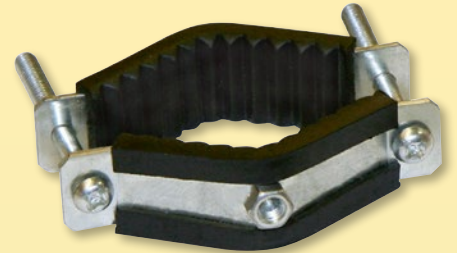

ref. no.			€
441276	1	20	

Ring Insulator with Metric Thread

- black
- with M6 metric thread
- galvanised 6 mm support
- sturdy plastic body
- 2 distance rings

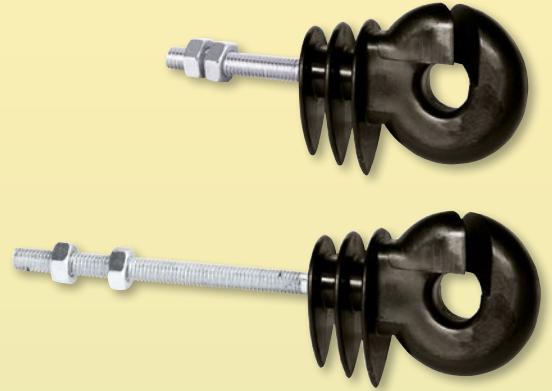

ref. no.	thickness	use				€
44324	M6 x 35 mm	Metal post	25	-	500	
44324/204	M6 x 35 mm	Metal Post	-	20	280	
44391	M6 x 80 mm	tube post	25	-	500	

Tape Insulator with Metric Thread

- thread length: 35 mm / M6
- for tapes up to 40 mm width and polywire up to 6 mm
- 2 nuts included in scope of supply

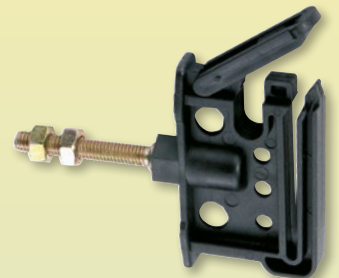
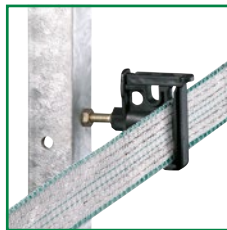

ref. no.			€
441392	25	500	

Offset Tape Insulator with Metric Thread

- keeps live wires away from the posts
- thread length: 100 mm / M6
- with 200 mm-long support
- for tapes up to 40 mm width
- 2 nuts included in scope of supply

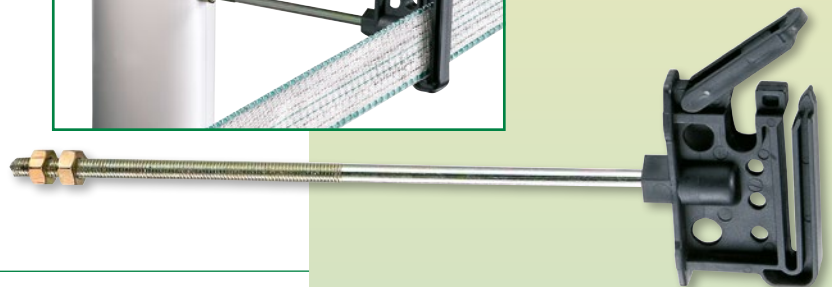
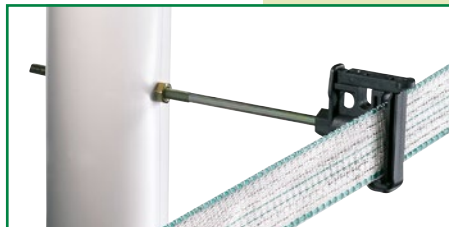

ref. no.			€
441393	10	300	

Corner Insulator with Metric Thread

- reinforced model
- roll complete with solid support and metric thread M6
- rotatable insulator
- 2 nuts included in scope of supply

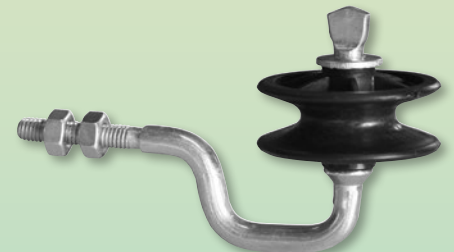
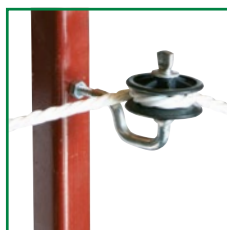

ref. no.			€
441394	25	250	

Gate Handle Insulator with Metric Thread

- hooks in gate handles from both sides
- with galvanised 6 mm support
- thread length: 35 mm / M6
- 2 nuts included in scope of supply

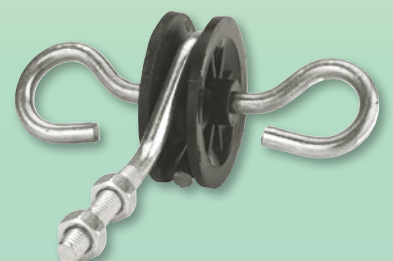
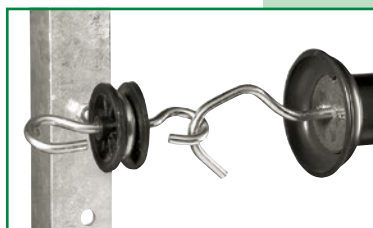



ref. no.			€
441241	10	250	

Offset Insulators

Offset Ring Insulator



- keeps live wires away from the posts
- with support of 22 cm length
- for ropes up to \varnothing 8 mm polywire

ref. no.			€
44310	10	-	300
44310/154	-	15	180



Offset Ring Insulator

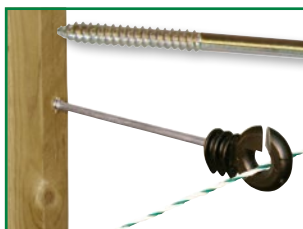

- keeps live wires away from the posts
- with support of 22 cm length

ref. no.			€
441480	10	300	



Offset Rope Insulator



- keeps live wires away from the posts
- with support of 22 cm length
- for electric ropes up to \varnothing 8 mm

ref. no.			€
44385	10	200	



Offset Tape Insulator

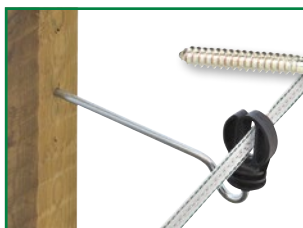

- keeps live wires away from the posts
- with support of 22 cm length
- for tapes up to 20 mm width

ref. no.			€
44312	10	-	300



Offset Tape Insulator

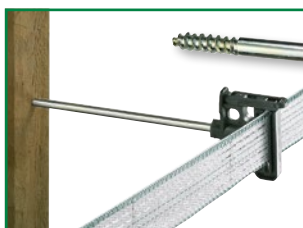

- keeps live wires away from the posts
- with support of 20 cm length
- for tapes up to 40 mm width and ropes up to \varnothing 6 mm

ref. no.			€
441395	10	-	300
441395/154	-	15	180



Offset Pigtail Insulator



- suitable as a spacer
- with wood thread
- for stranded wires, ropes and tapes up to 40 mm

ref. no.	description			€
441867	with 25 cm support	5	100	
441868	with 40 cm support	5	100	



Offset Pigtail Insulator

- support of 40 cm length
- attaches with staple (item no. 44394)

ref. no.			€
44448	10	50	

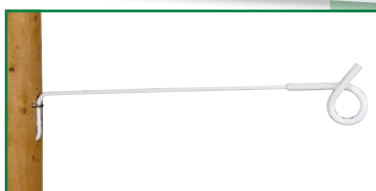

New!

Supplementary Insulators

Screw Insulator Vario Plus

- for metal or plastic posts up to 17 mm dia.
- mounted on side of post and easily tightened
- patented

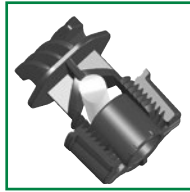

441386



441387

VARIO Plus

Strip protection:
The thread can no longer strip!

ref. no.	use					€
441386	for tapes up to 40 mm width	10	-	200	-	
441386/154	for tapes up to 40 mm width	-	15	375	-	
441387	for polywire, wire and rope	10	-	200	-	
441387/204	for polywire/stranded wire, wire and wire rope	-	20	-	-	

Supplementary Clip Insulator Allround

- for metal or plastic posts up to 19 mm diameter
- holds polywire and tape up to 20 mm width
- easy to integrate in already installed fence

ref. no.			€
44446	10	200	



Screw Tight Insulator for Round Posts

- for metal or plastic posts up to 12 mm diameter
- holds polywire and wire
- mounts from above

ref. no.			€
44387	10	200	



Nail-on Insulator

- suits polywire and wire
- supplied with nail

ref. no.	description			€
44367	with 7 cm nail	50	700	
44368	with 10 cm nail	50	400	

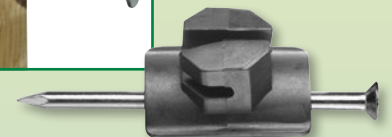
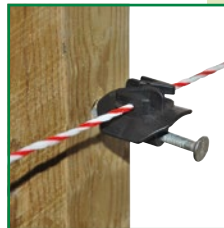

Nail-on Insulator

- with knob
- suits polywire and wire
- delivery without nail

ref. no.			€
44360	100	1,800	



Nail-on Insulator

- secures polywire or steel wire
- delivery without nail

ref. no.			€
44361	100	1,800	

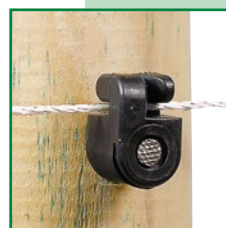

Permanent Fencing

Drill

- the ideal aid for fence building
- fatigueless drilling before posts are set up

ref. no.	Ø		€
44484	70 mm	1	
44485	90 mm	1	
44486	150 mm	1	

Post Driver

- for driving in posts up to Ø 100 mm
- weight approx. 12 kg

ref. no.		€
44471	1	

Wooden Mallet

- 6 kg
- incl. welded scorper

ref. no.	description		€
44482	Wooden Mallet	1	
44483	Spare Stick for Wooden Mallet	1/10	

Sledge Hammer plastic

- 5 kg
- made of break-proof plastic

ref. no.		€
441422	1	

Premium Farming forceps

- superlative quality and reliability
- special wire cutters - ideal for permanent fence wire Ø 2.0 and 2.5 mm
- with parallel grip jaws
- Made in the EU

ref. no.		€
442566	1/10	

Farming forceps

- cuts wire up to Ø 5 mm
- essential for fence construction
- can also be used as a hammer

ref. no.		€
28255/1	1/6/36	



Permanent Fencing

In-Line Strainer

- tightens/loosens rapidly wires, ropes, polywires without cutting them in two

ref. no.	description	SB	☐	€
44513	In-Line Strainer	-	1/25	
44513/036	In-Line Strainer	3	1/50	
44514	Tension arm	-	1/20	

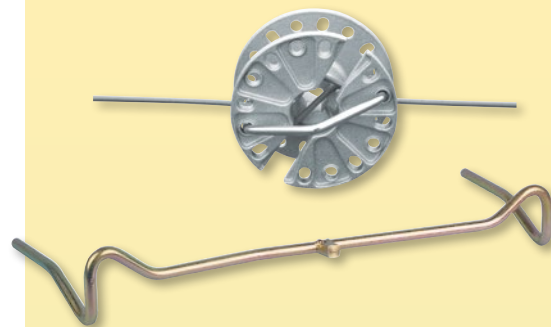

Permanent Wire Strainer

- tightens/loosens rapidly wires, ropes, polywires without cutting them in two
- with cliplock
- without lever

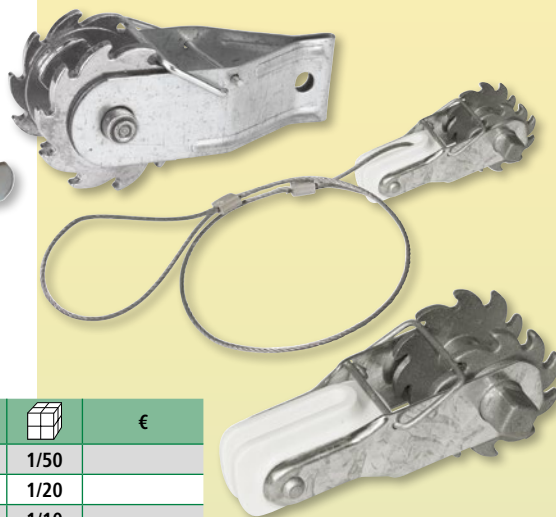

ref. no.	description	☐	€
44509	Gear-toothed Wire Tensioner	1/50	
441327	Gear-toothed wire tensioner with integrated insulator	1/20	
441297	Gear-toothed wire tensioner with integrated insulator and wire cable	1/10	
441328	Clamping lever for gear-toothed wire tensioner	1/20	

Tensulator

One product that connects, tightens, attaches and insulates – four functions in one.

This tensulator installs 4 times faster than conventional fence components

- easy to use – bending and turning wire ends (cuts and grazes on your hands are a thing of the past)
- ideal for all fencelines
- tightens and re-tightens
- corrosion-resistant components for insulation and more lifetime
- fits all wire gauges from 2.00 mm to 3.15 mm
- working load 200 kg
- new collet chuck with pulling force adjustment (for extracting posts)



ref. no.	description	SB	☐	€
44697	Tensulator	10	1/10	
44703	Tension Tool	-	1/4	

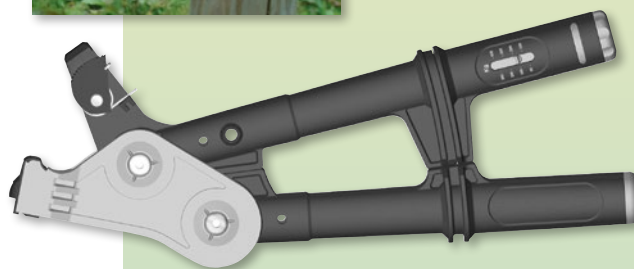

Temperature Equalisation Spring

- sturdy model for 2.5 mm steel wire
- eases strain on wire and corner posts
- balances temperature variations and renders the fence flexible

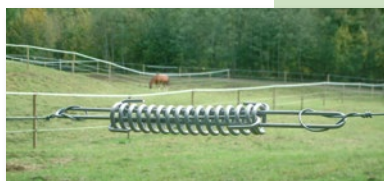

ref. no.	length	Ø spring	material	☐	€
44704	435 mm	43 mm	galvanized	1/20	
44705	435 mm	43 mm	stainless steel	1/20	
44259	200 mm	25 mm	stainless steel	1/125	
446506	500 mm	-	Protective hose for temperature equalisation springs	1/10	

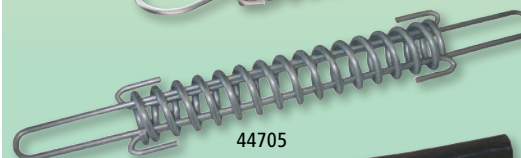
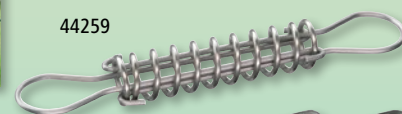



Permanent Fencing

High-Tensile Steel Wire for Permanent Fence





- zinc/aluminium alloy for long lasting protection
- ninefold protection against corrosion compared to galvanized wire
- extremely good conductivity
- ideal for permanent fence installations
- optimum current output upon animal contact



ref. no.	length	Ø	resistance Ω/m	breaking strength			€
445055	1000 m	2,0 mm	0,060	345 kg	1	40	
44505	625 m	2,5 mm	0,035	650 kg	1	40	

PinLock Rope Insulator



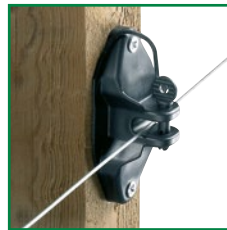

- heavy-duty insulator
- ideal for all ropes up to Ø 8 mm polywires and steel wires

ref. no.					€
441495	25	-	500	-	



Permanent Fencing Insulator Highland

- black
- professional insulator for permanent fencing
- nail-on or screw-in insulator
- ideal for steel wires

ref. no.					€
441398	10	-	200	-	





10 years UV warranty



Strain Insulator Polyamide for Steel Wire

- with fibreglass reinforcement
- suitable as corner and strain insulator in permanent fencing (plain wire)
- resists especially high strains

ref. no.				€
44358	10	-	250	



Porcelain Corner Insulator

- professional corner insulator made of porcelain
- high-quality
- withstands extreme tensile loads

New!

ref. no.		€
442362	10	



Kramp Nail

- 3.8 x 47 mm
- galvanized

ref. no.		€
44394	50	



Gate Systems

Flexigate – The flexible Gate System



Flexigate makes it easy for you to electrify paddock entrances. On opening the tape or rope will be reeled up automatically by a steel spring.

Your advantages:

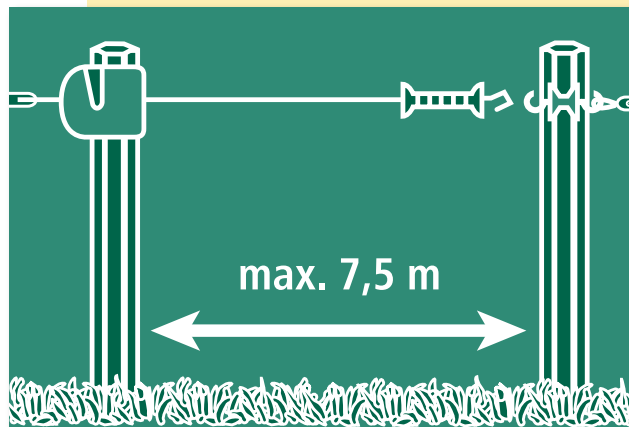
- secured with 2 included wooden screws DIRECTLY to the wooden stake
- NOW: extendable to max. 7.5 m
- no sagging of tapes or ropes
- no stumbling for humans and animals
- no tail hair gets stuck
- no dirty tapes/ropes
- end-to-end electrical contact



Especially suitable for fence systems. End-to-end electrical contact.

ref. no.	description	length			€
441234/016	Flexigate with 40 mm tape	max. 7,5 m	1	10	
441293/016	Flexigate with rope	max. 7,5 m	1	10	

connecting cable not included

Gate Systems

Electric Fence Gate Electro Gate

Set includes:

2 sticks, 2 hinges and insulated ground cable (item no. 44283 consists of 1 stick, 1 hinge and ground cable)

- powered by fences and easy to integrate in already installed fence systems
- available for entrances of 3.60 m, 5 m or 6 m as well as mini electro gate of 1.20 m
- the flexible fibre-glass sticks are covered with electrically conductive rubber
- insulated gate handles for pedestrians
- the physical law of the Faraday cage protects the driver against electric shocks
- opens in both directions and self-closing behind
- lockable in open position



ref. no.	description		€
441287	Electric Gate Kit complete 6,00	1	
44282	Electric Gate Kit complete 5,00 m	1	
44281	Electric Gate Kit complete 3,60 m	1	
44283	Mini Electric Gate 1,20 m	1	
441288	Spare Stick 3,0 m	1	
44285	Spare Stick 2,50 m	1/50	
44284	Spare Stick 1,80 m	1/50	
44286	Spare Hinge (one piece)	1	



E-line Gate Kit

- with tensile electric fencing rope
- convenient and handy gate for fence openings either up to 6 m or up to 9 m
- no mane or tail hair gets stuck
- stainless steel hook

set includes:

1 x Ø 7 mm tensile electric fencing rope (3 years warranty), with hook, with 4 x 0.25 mm stainless steel conductors

1 x sturdy gate handle

1 x ring insulator

1 x gate handle insulator

ref. no.	description			€
44255	E-line (3,0 - 6,0 m length)	1	16	
44251	E-line (4,5 - 9,0 m length)	1	16	

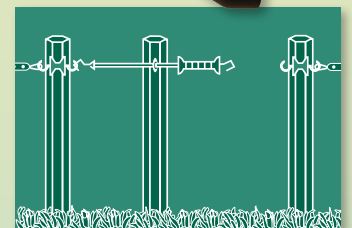

Especially suitable for horse paddocks!

Eco Gate System

Inexpensive FlexiRope Gate Handle Set available in 2 lengths. Can be extended to around twice the length.

- with tensile electric fencing rope
- no tail hair gets stuck

New!

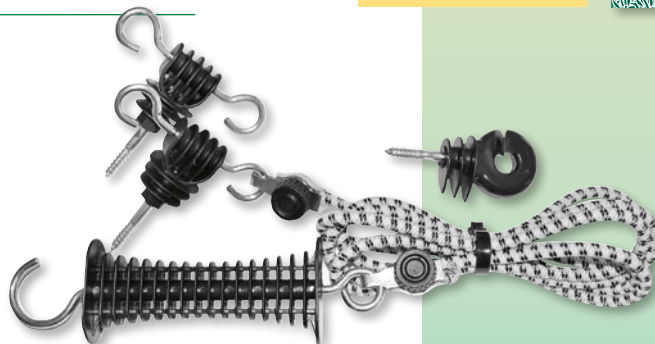

ref. no.	description			€
441865	Eco Gate System (3.0 - 6.0 m length)	1/15	15	
441866	Eco Gate System (4.5 - 9.0 m length)	1/15	15	
441890	Rubber electric hoist 25 m	1/8	200	
441891	Rubber electric hoist 50 m	1/4	200	

Gate Systems

Gate Kit

- stretches up to about 5 m

Kit consists of:

- 1 gate handle with hook
- 1 special spring
- 2 x gate insulators (not suitable for horse containment)

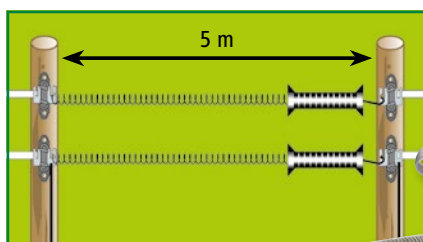

44246

ref. no.	use			€
44945	Kit with Ring Insulator and Gate Insulator	1	15	
44246	Spare spring galvanized	-	20	

Gate Handle with Spring

- stretches up to about 5 m

ref. no.		€
449535	1/20	

Vario Profi Gate Handle Insulator

- incl. connecting plate made of stainless steel
 - with 3 connection options for gate handles
 - hole spacing: 94 mm
- NEW: Professional version now larger, extremely robust, made from polycarbonate!

ref. no.			€
446505/046	1	14	

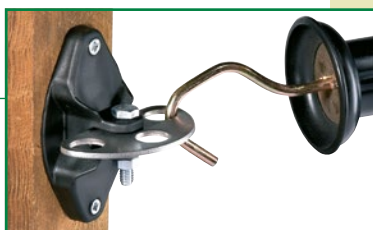

Gate Handle Insulator Vario

- Set includes:
2 x insulators, 2 x connection plates which allow to connect 3 gate handles each

ref. no.	description			€
44237/026	Kit complete	2	1/50	

Gate Handle Insulator

- hooks in gate handles from both sides
- practical and safe
- 360° swivel loops



ref. no.	description				€
44248	Gate Handle Insulator	10	-	250	
44248/066	Gate Handle Insulator	-	6	300	
44254	Gate Handle Insulator stainless steel	10	-	250	

Gate Handle Insulator with Metric Thread

- hooks in gate handles from both sides
- with galvanised 6 mm support
- thread length: 35 mm / M6
- 2 nuts included in scope of supply

ref. no.			€
441241	10	250	

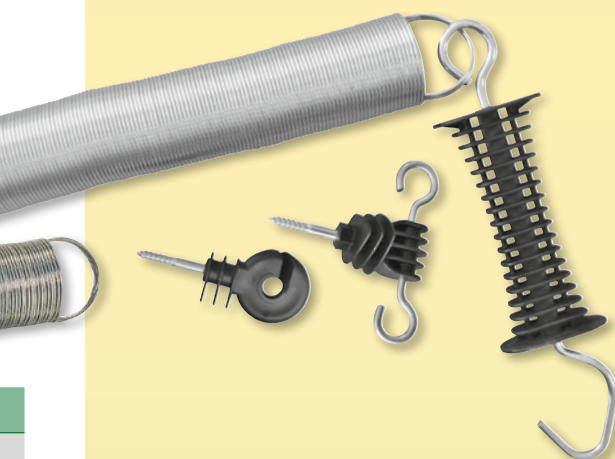
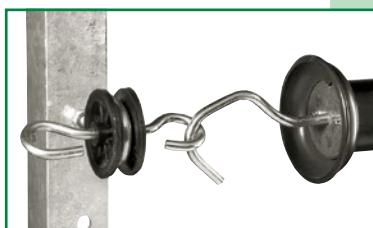

Stainless steel

New!



Stainless steel

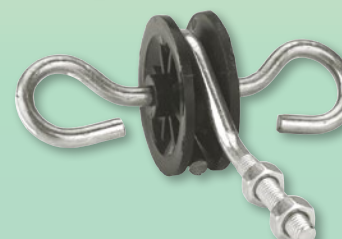
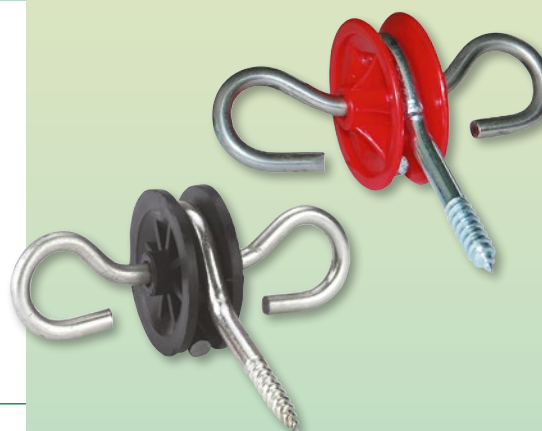

Gate Handles

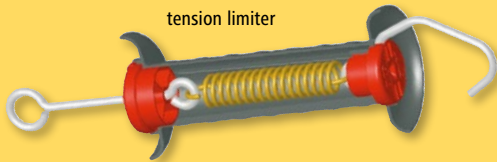

tension limiter

- with tension limiter to prevent over-stretched spring
- heavy-duty quality
- UV-stabilised plastic
- excellent insulation

Premium Plus Gate Handle

- with hook
- robust, durable gate handle through screwed metal sealing caps
- with tension limiter
- made from stainless steel

ref. no.	colour	MQ		€
44966	red	10	1/10/50	



Extra sturdy!

Premium Gate Handle

- with hook
- made of stainless steel for excellent corrosion resistance
- prevents over-stretched springs

ref. no.	colour	MQ		€
44944	red	5	1/5/100	

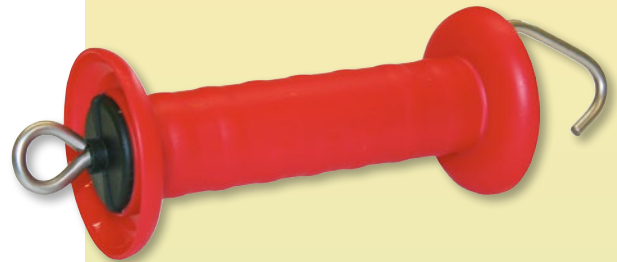

Premium Gate Handle with Litzclip® Tape Connector

- with hook and stainless steel Litzclip tape connector
- hook and eyelet made from non-rusting stainless steel – ensures excellent corrosion resistance
- with tension limiter

ref. no.	description	MQ		€
4494420	Gate Handle with Premium Litzclip BV 20 mm Stainless Steel	5	1/5/100	
4494440	Premium Gate Handle with BV 40 mm Niro Wire Clip	5	1/5/100	



Gate Handle with Litzclip® Tape Connector

- with galvanized hook and stainless steel Litzclip tape connector 20 mm
- with tension limiter

ref. no.	description	MQ		€
4494120	Gate Handle Galvanised with Litzclip BV 20 mm Stainless Steel	5	1/5/100	
4494140	Gate Handle Galvanised with Litzclip BV 40 mm Stainless Steel	5	1/5/100	



Litzclip® Gate Handle Connector for Tape

NEW AND RELIABLE!

The new tool-free gate handle connectors for 10, 20 mm and 40 mm fence tapes are expanding our patented, successful Litzclip range. The stainless steel connectors ensure a secure and fast fixing of the fence tape and optimum electrical contact to the connection plate thanks to the durable plastic closure cap => perfect conductivity. The connectors are self-explanatory in function and can be very quickly and easily installed on any gate handle or gate isolator. Tapes can therefore also be very easily re-tightened.

Made in Germany

ref. no.	use	material		€
442006/046	10 / 20 mm tapes	Stainless steel (INOX)	4	
442007/046	40 mm tapes	Stainless steel (INOX)	4	



Stainless steel



Gate Handles

Gate Handle with Tape Connector

- with hook and tape connector 40 mm
- with tension limiter

Important: Not suitable for strips with copper wires!

ref. no.	colour	MQ		€
44947	black	5	1/5/100	

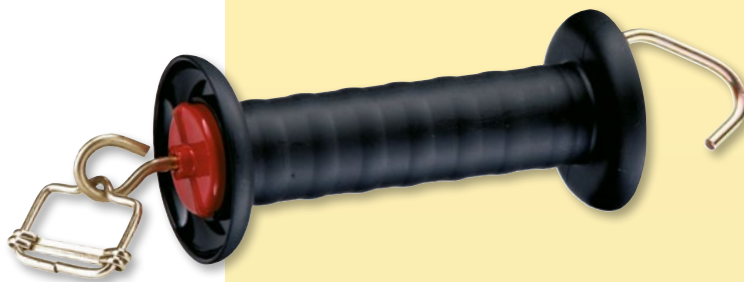

Gate handle with rope and wire connection*

- newly designed gate handle incl. rope and polywire connector (already fixed to the gate handle)
- also suitable for tapes from 10 to 20 mm
- with hook
- with tension limiter

*Advantage: no tools are necessary - optimal electrical connection can be achieved simply with a locating screw. Also ideal for readjusting tension.

ref. no.	description	colour	MQ			€
44948	Gate handle for rope and wire	black	5	-	1/5/100	
441209/041	Quick connector for Polywire and rope	-	1	4	1	

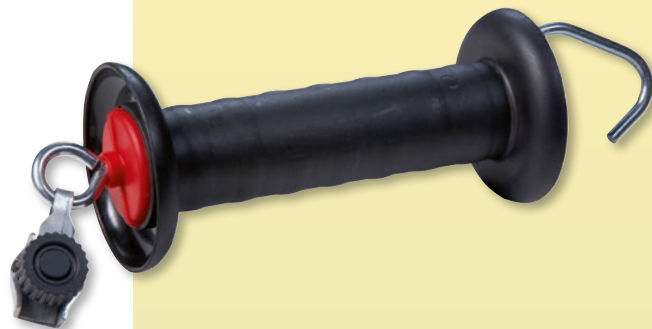

Gate Handle

- with tension limiter

ref. no.	description	colour	MQ		€
44940	with eyelet	black	5	1/5/100	



Gate Handle

- with hook
- with tension limiter

ref. no.	colour	MQ			€
44941	black	5	1/5/100	2,200	



Gate Lock

Insert the gate handle into the mounting plate - push the safety covering across - lock the padlock - finished! The gate handle is now fixed to the locked security casing, thus ensuring that only authorised persons have access to the field.

The set is made up of:

- gate handle insulator with strong plastic and stainless steel mounting plate
- gate handle with spring tension limiter
- two-part security casing: wall or post fixture + safety cover
- 2 fastening screws
- brass padlock with 2 keys

ref. no.		€
441235	1	

Lockable gate system

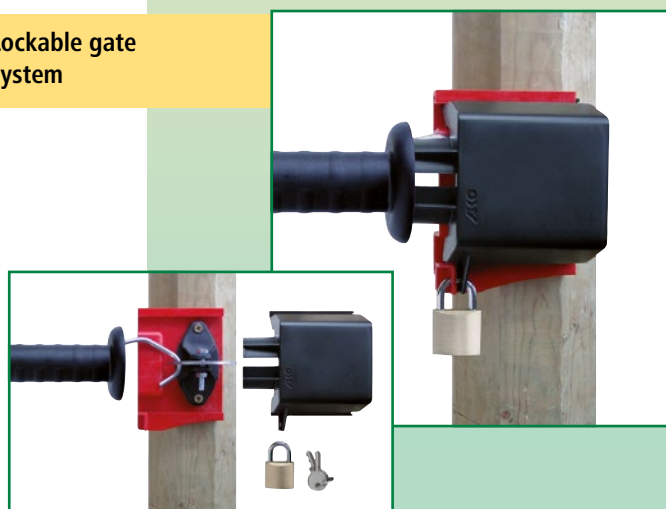



Gate Handles

Gate Handle

- with hook
- with simple tension spring
- galvanized





ref. no.	colour	MQ			€
44951	black	5	1/5/100	2,200	
44957	pink	5	1/5/100	2,200	
44958	neon purple	5	1/5/100	2,200	
44959	neon green	5	1/5/100	2,200	
44960	neon orange	5	1/5/100	2,200	
44953	yellow	5	1/5/100	2,200	
44961	petrol	5	1/5/100	2,200	

Gate Handle

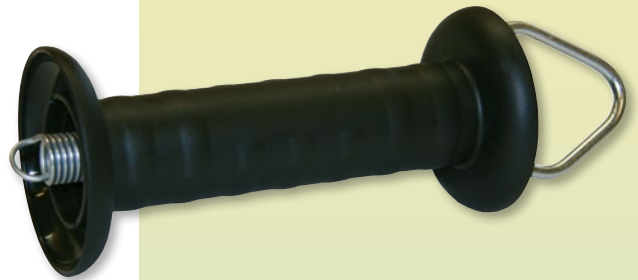
- with eye
- with simple tension spring
- minimum ordering quantity 5 units





ref. no.	colour	MQ			€
44952	black	5	1/5/100	2,200	

Gate Handle

- with hook
- with tension limiter



ref. no.	colour	MQ			€
44241	black	5	1/5/100	1,800	

Gate Handle, black

- with hook
- with simple tension spring

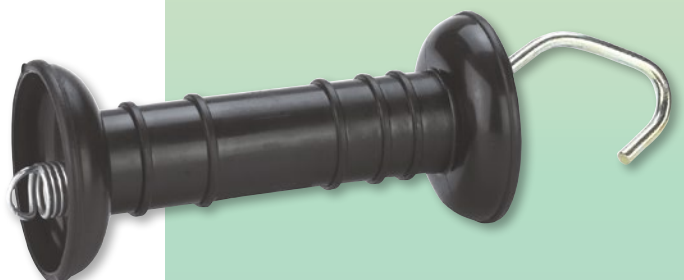

ref. no.		€
44251	1/5/100	

Pasture Gates

Pasture gates, adjustable, 110 cm

- stable, galvanised steel paddock gate, including installation kit
- height: 110 cm

Installation kit comprising:

- 2 hinges
- 1 closure option
- NEW: includes 6 wood screws (12 x 80 mm)



Offset mounting of the hinge can be adjusted by moving the threaded hinge pin!



extends by adjustable set screw



lockable (padlock not included)



442577

Offset mounting of the hinge can be adjusted by moving the threaded hinge pin (which is height-adjustable).











Can be closed as an option (without lock)



442578

442579

ref. no.	description		€	
44893	Fence Gate 1 - 1,7 m, adjustable	1		
44892	Fence Gate 2 - 3 m, adjustable	1		
44891	Fence Gate 3 - 4 m, adjustable	1		
44895	Fence Gate 4 - 5 m, adjustable	1		
442557	Fence Gate 5 - 6 m, adjustable	1		
442577	2 m gate post with plastic cap, Ø 88 mm	1		
442578	Fastener for gate posts	1		
442579	Hinge pin bracket for gate posts (in pairs)	1		

Shipping costs will be charged separately!

Pasture Gates

Pasture gates, adjustable, 90 cm

- stable, galvanised steel pasture gate included in each mounting set
- height: 90 cm

Mounting set consists of:





- 2 hinges
- 1 closing option
- NEW: includes 6 wood screws (12 x 80 mm)

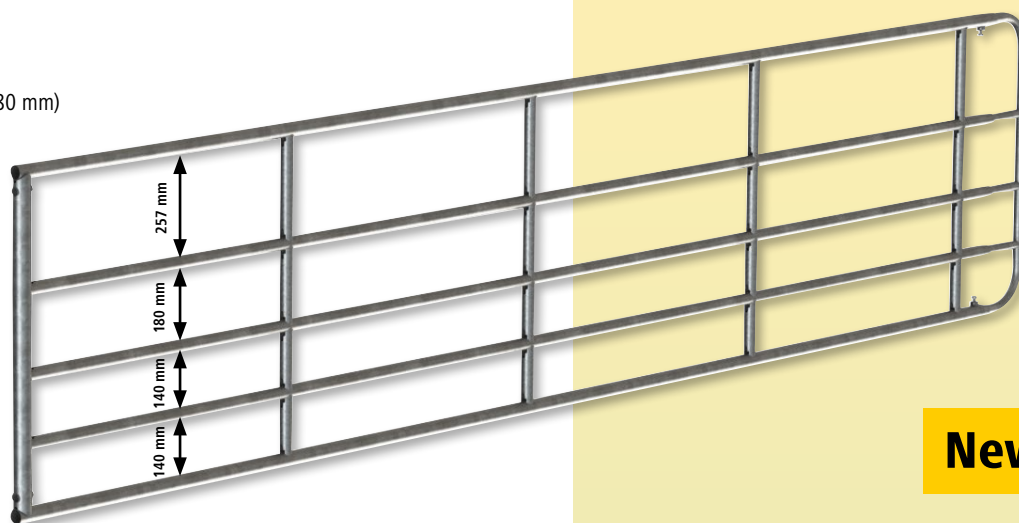

442940



New!

ref. no.	description	length		€	
442900	Adjustable Pasture Gate, galvanised	2 - 3 m	1		
442901	Adjustable Pasture Gate, galvanised	3 - 4 m	1		
442902	Adjustable Pasture Gate, galvanised	4 - 5 m	1		
442940	Locking bolt	-	1		

Shipping costs will be charged separately!

Pasture gates, fixed, 100 cm

- stable, galvanised steel pasture gate included in each mounting set
- 6 different models with fixed widths (min. 3 m – max. 6 m)
- height 100 cm
- not adjustable

Mounting set consists of:







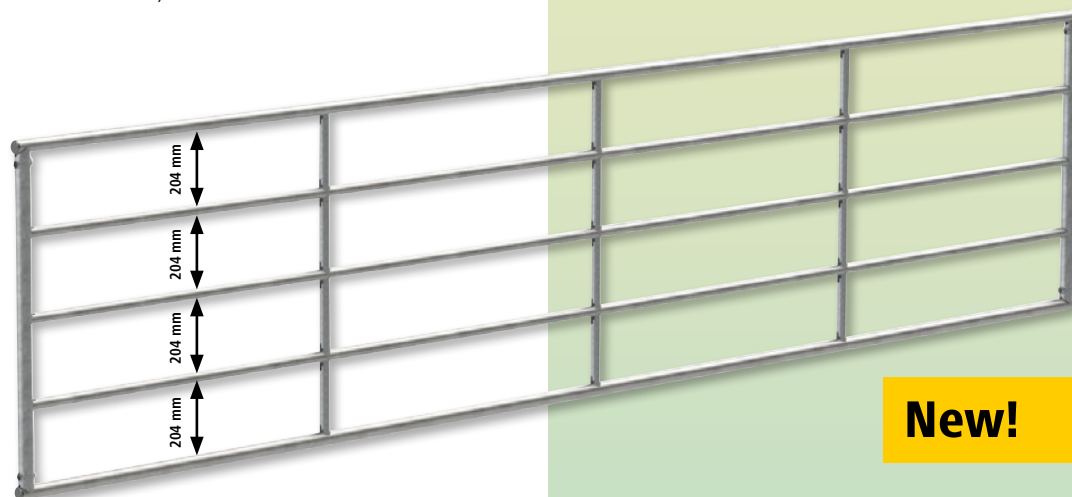

- 2 hinges
- 1 closing option
- NEW: includes 6 wood screws (12 x 80 mm)



442940



New!

ref. no.	description	length		€	
442920	Fixed Pasture Gate, galvanised	3 m	1		
442921	Fixed Pasture Gate, galvanised	3,5 m	1		
442922	Fixed Pasture Gate, galvanised	4 m	1		
442923	Fixed Pasture Gate, galvanised	4,5 m	1		
442924	Fixed Pasture Gate, galvanised	5 m	1		
442925	Fixed Pasture Gate, galvanised	6 m	1		
442940	Locking bolt	-	1		



Shipping costs will be charged separately!

Pasture Gates

Swing-Through Lock for Fence Gates

• the swing-through lock allows the gate to be opened in both directions • the lock is fitted to the stake and gate using the screws supplied • can be used on all fence gates

ref. no.		€
441025	1/6	



Stabiliser for Adjustable Pasture Gates

• hot-dip galvanised steel parts, full rubber wheel Ø 200 mm

ref. no.		€
442559	1	



Electrics Kit for Fence Gates

Kit for additional electrification of your fencing system around fence gates • fence gate can continue to be opened by hand • set includes:

- 6 fastening rings
- 6 ring insulators with metric thread
- 1 rope/tape connection
- 14 m rope (Top Line Plus) with 6 mm

ref. no.		€
441224	1/16	



Allen key safety screw set

for adjustable pasture gates

- size: length 20 mm
- thread: M10
- material: Stainless steel
- contains 2 screws

New!



The screws are completely countersunk to prevent injuries to your animal from the screw head

ref. no.		€
442588	1	



Fence panels

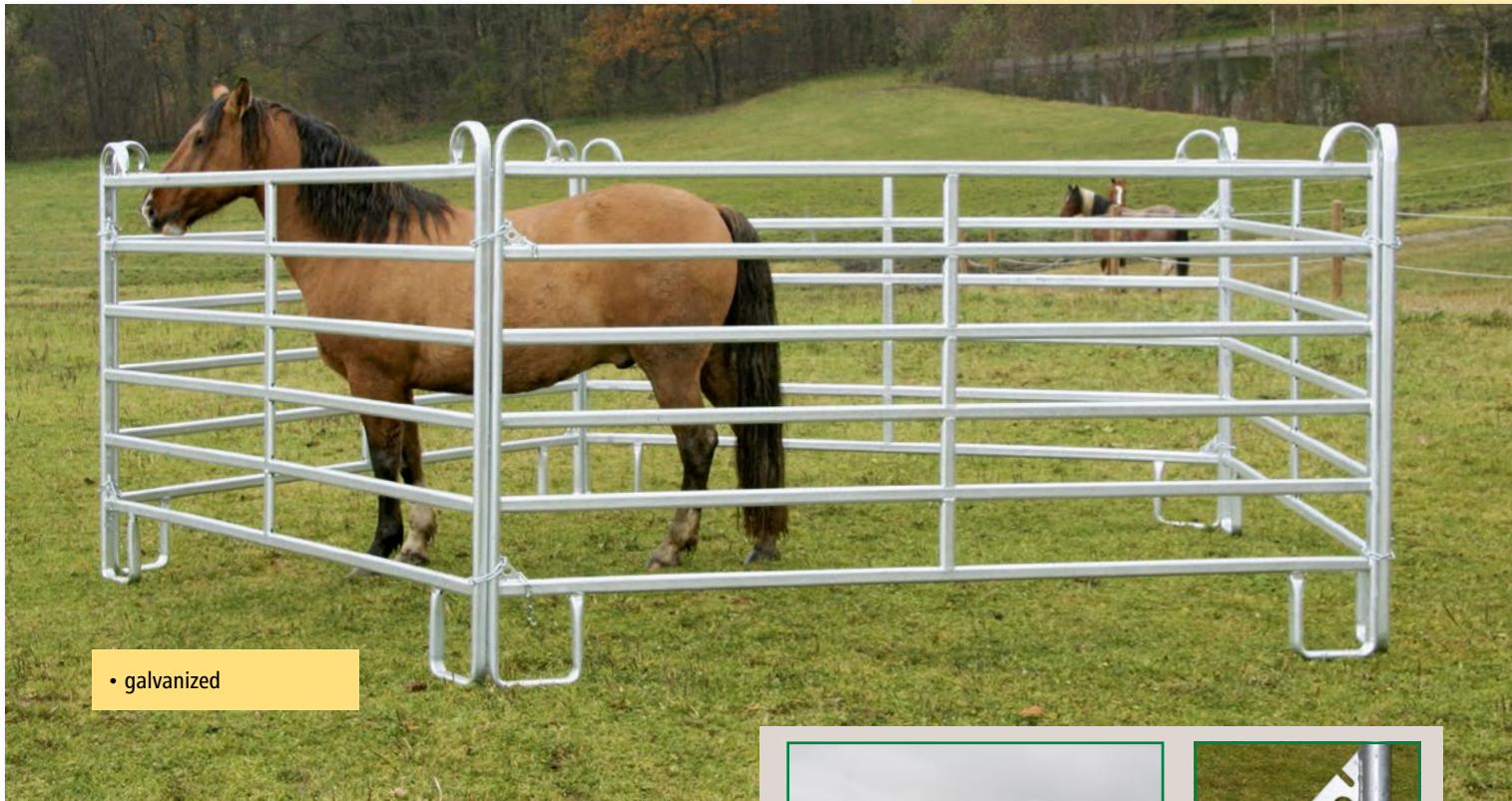

• galvanized

Fence Panel

- perfect for erecting mobile and flexible fencing as well as temporary horse boxes
- also commonly used to fence off riding and training areas
- height of upper tube 1.6 m
- total height 1.70 m
- safety mounting bracket prevents animals from being injured. When landing on the panel, the animal does not fall between two panels if it slips
- smooth oval tube 50 x 30 x 1.5 mm
- clear distance between tubes 20 cm
- rapid chain fastening makes it quicker and easier to connect several panels
- very stable at light loads
- curved feet ensure excellent stability
- galvanized



safety mounting bracket







rapid chain fastening



secure stand because of U-shaped foot



Shipping costs will be charged separately!

ref. no.	description	length		€	
442591	Fence component without gate	2,4 m	1		
442592	Fence component without gate	3,0 m	1		
442593	Fence component without gate	3,6 m	1		

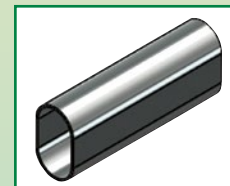

dimensioning flat oval tube: 50 x 30 x 1.5 mm

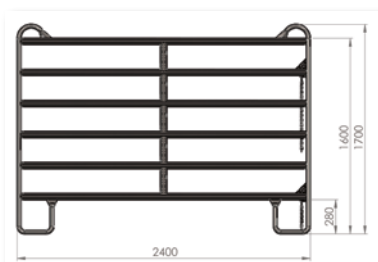

dimensioning 442591

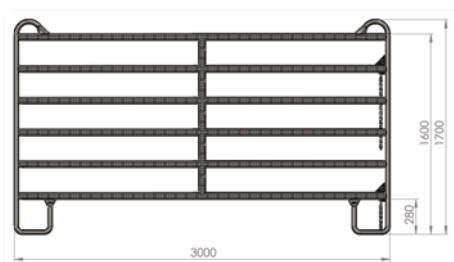

dimensioning 442592

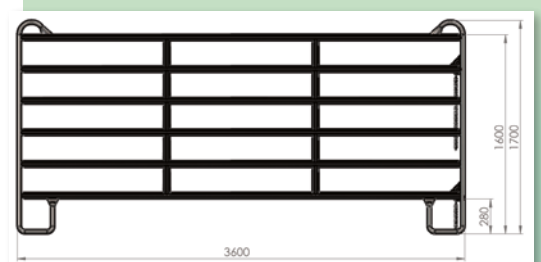

dimensioning 442593

Fence panels

Fence Panel with Gate

- allows an opening to be created in the fencing
- total height 2.2 m
- gate width 1 m
- lock for opening and closing the fenced area
- galvanized



Example for mounting

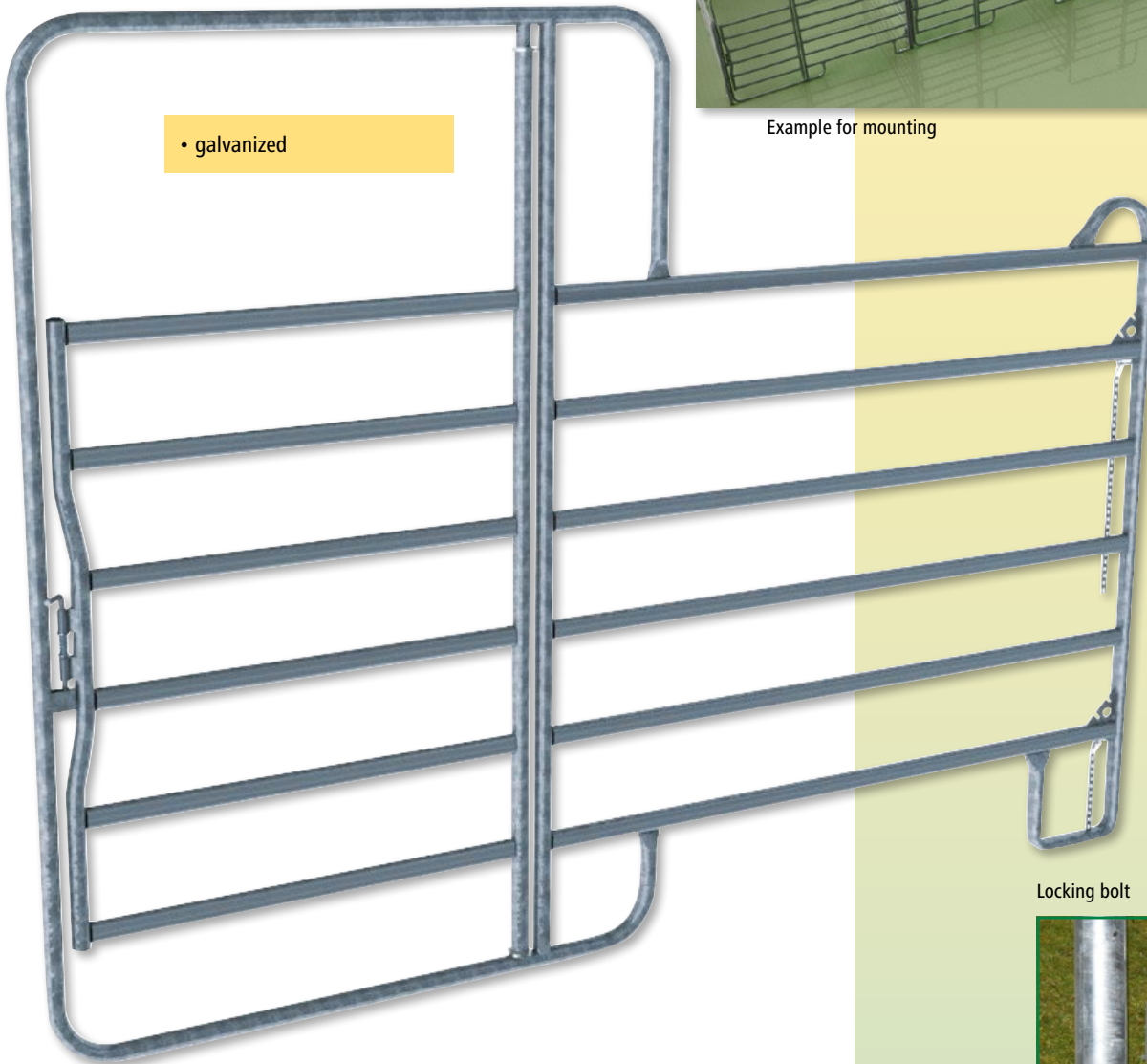

• galvanized

Locking bolt



Shipping costs will be charged separately!

ref. no.	description	length		€
442594	Fence component with gate	2,4 m	1	
442595	Fence component with gate	3,0 m	1	
442596	Fence component with gate	3,6 m	1	

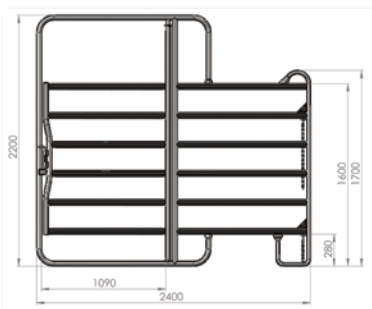

dimensioning 442594

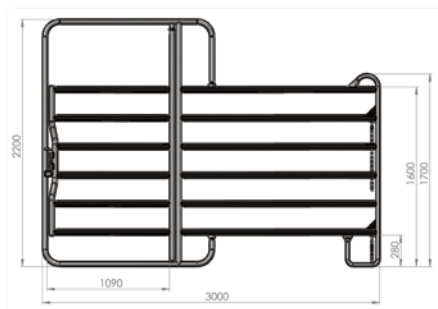

dimensioning 442595

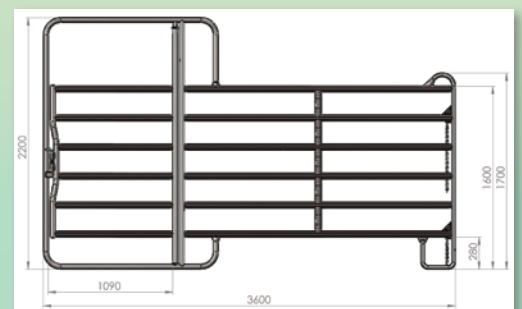

dimensioning 442596

Fence panels

Modular Hoarding

- practical connecting system for easy and tool-free installation of hoardings • suitable for the creation of pre-gathering spaces, pens, individual and group boxes or stall dividers • 7 cross tubes with increasing distance from bottom to top, tube diameter 25 mm or 21,3 mm • completely hot-dip galvanized • height: 92 cm • door with lock latch and reinforced frame, width of 57 cm
- centrally located feeding device with adjustable width (18 cm / 25 cm)



442606

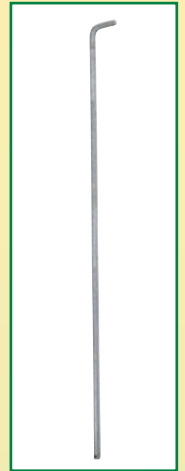

442608



32702

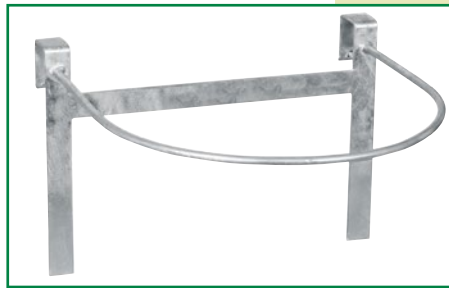

442607

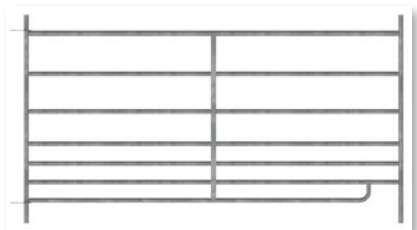



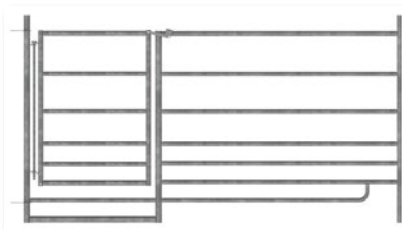



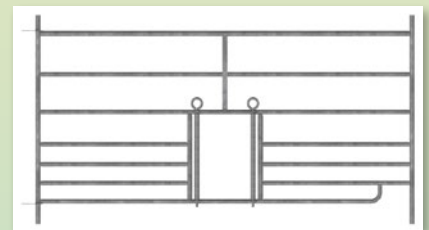

442601



442603



442605

ref. no.	description			€	
442600	Modular hoarding, 1.37 m	1	80		
442601	Modular hoarding, 1.83 m	1	80		
442602	Modular hoarding, 2.75 m	1	80		
442603	Modular hoarding with gate, 1.83 m	1	68		
442604	Modular hoarding with gate, 2.75 m	1	60		
442605	Modular hoarding with feeding device, 1.83 m	1	60		
442608	95 cm connecting rod for modular hoarding	1	-		
442606	Additional rod for connecting hoardings with rods	1	-		
442607	Bucket holder for hanging, ø 30 cm	1	-		
32702	Double hopper for insertion, bar spacing 80 mm	1	50		
32704	Double hopper for attachment, rod distance 40 mm	1	50		



Hay Racks

Square Hay Rack for Horses with Safety Feeding Barrier

- universal hay rack with 12 slots for horses
- suitable for round and rectangular bales up to 1.8 m in length or diameter
- extremely stable design, high material thickness, 2 square pipe beams
- galvanized
- 2 sides can easily be opened for filling
- height-adjustable runners (adjustable to the animal's size)
- three point attachment
- very little food loss
- supplied as a construction kit including circumferential roof edge protection, three-point safety clip
- internal trough dimensions: approx. 2 x 2 m
- complete dimensions L x W x H: approx. 2.12 x 2.12 x 2.5 m



Shipping costs will be charged separately!



ref. no.		€	
291256	1		

Four-sided Manger for Palisade Feeding Grid

- 12 feeding places
- universal hay rack for horses and cattle
- suitable for round and rectangular bales up to 1.8 m in length or diameter
- extremely stable design, high material thickness, 2 square pipe beams
- galvanized
- 2 sides can easily be opened for filling
- height-adjustable runners (adjustable to the animal's size)
- three point attachment
- very little food is wasted
- supplied as a construction kit including circumferential roof edge protection, three-point safety clip
- internal trough dimensions: approx. 2 x 2 m
- dimensions L x B x H: approx. 2.12 x 2.12 x 2.5 m



Shipping costs will be charged separately!

ref. no.		€	
291255	1		



Three point attachment (with safety guard)



Circumferential roof edge protection



Square Tube Support Beams

Hay Racks

Four-sided Manger for Palisade Feeding Grid "Standard"

- 12 feeding places • universal hay rack for horses and cattle
- suitable for round and rectangular bales up to 1.8 m in length or diameter
- 1 square tube support beams • galvanized
- 2 sides can easily be opened for filling
- height-adjustable runners (adjustable to the animal's size)
- three-point attachment
- very little food loss • supplied as a construction kit including circumferential roof edge protection, three-point safety clip
- interior trough dimensions: approx. 2 x 2 m • dimensions L x B x H: approx. 2.12 x 2.12 x 2.5 m

Shipping costs will be charged separately!

ref. no.		€	
291289	1		



Circumferential roof edge protection



Three-point hitch (with safety guard)



Round Rack with 8 Feeding Slots

- 8 feeding places • palisade feeding grid • supplied as self-assembly kit • 4-part, can be transported in an estate car
- outdoors or in play pens, the segments can also be used to set up wall or corner mangers • galvanized

technical data	
external diameter:	approx. 150 cm
internal diameter:	approx. 132,5
height:	approx. 116 cm

ref. no.		€	
291257	1		

Shipping costs will be charged separately!



Round Rack with 12 Feeding Slots

for regular and round bales

- 12 feeding slots • palisade feeding grid • supplied as self-assembly kit • consists of 3 parts • three point attachment
- includes three-point safety clip and top bar safety cap
- galvanized

Shipping costs will be charged separately!

technical data	
external diameter:	approx. 236 cm
internal diameter:	approx. 219 cm
height:	approx. 116 cm

ref. no.		€	
291258	1		



three-point attachment



Slow Feeding Net

- the net is placed over the food/bales so that the animals eat more slowly and thoroughly, helping to improve their digestion • reduced dust formation • appropriate feeding • little food is wasted

- art. 291295 galvanised frame
- for easier fastening of the slow feeding net
- convenient and quick to fold up and down

New!

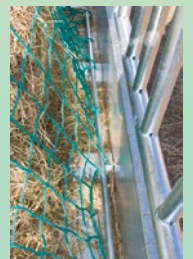

ref. no.	description	length	width		€	
291260	Slow feeding net, mesh width 4,5 cm	3,6 m	2,4 m	1/6		
291261	Slow feeding net, mesh width 10,0 cm	3,6 m	2,4 m	1/10		
291262	Slow feeding net, mesh width 4,5 cm	2,8 m	2,8 m	1/6		
291263	Slow feeding net, mesh width 10,0 cm	2,8 m	2,8 m	1/12		
291295	Frame for slow feeding net	1,9 m	1,9 m	1		

Hobby Kits

Tournament/Paddock Set 7 x 7 m

- new Tournament/Paddock Set for approx. 7 x 7 m
- set consists of 4 galvanised metal posts with a 153 cm total height
- metal posts are ideally suited for dry and rocky ground
- each comes with 2 x FlexiRope 4.5 m incl. gate handle with stainless steel hooks and 2 x matching gate handle insulators
- no catching of mane or tail hair
- with 2 x 1.5 V electric fence device AKO Compact Power B 40 (incl. batteries)
- everything complete in one carry bag
- set up and dismantled in just a few minutes
- weight with device: 13.5 kg, without device: 12.5 kg



Scan the QR code and watch the video or www.ako-agrar.de!

New!



ref. no.	description		€
446500	Tournament/Paddock Set 7 x 7 m without electric fence unit	1	
446501	Tournament/Paddock Set 7 x 7 m incl. 2 x 1.5 V battery unit Fence Device B 40	1	

Net gates



Door for electric fence nets, complete set

Enables quick and easy passage through fence netting.

Practical door for your electric netting. Quick and easy to install.

Can be installed to any position on the netting - can also be installed subsequently to a fence that has already be set up.

The green netting of the door is electrifiable, the stable frame is insulated.

When opening the door, the power does not have to be turned off.

- fast and easy to open and close
 - low weight, despite being sturdy and robust
 - opening width: 86 cm (sufficient for most gardening equipment)
 - incl. 2 jumbo standing posts, double-pointed
 - electrifiable, incl. cable and connections
 - quick and easy installation
 - delivery includes connection and connection accessories
- 105 cm: suitable for all nets up to 90 cm in height
 - 125 cm: extra-high version, suitable for a net height of over 95 cm up to 125 cm.

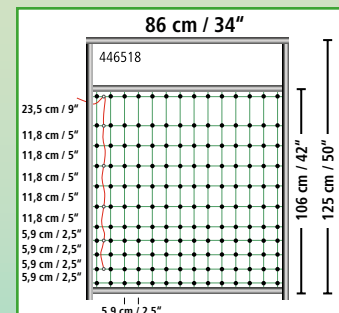
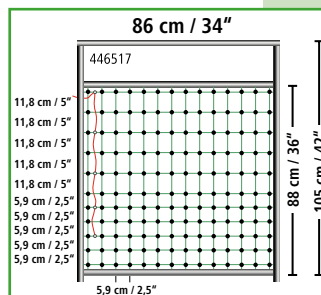

ref. no.	description	height		€
446517	Door for nets up to 90 cm	105 cm	1	
446518	Door for nets from 95 - 125 cm	125 cm	1	

Rabbit Netting

Rabbit Netting

- height of net 65 cm • electrifiable horizontals through 3 x 0.20 mm stainless steel conductors per strand • for power supply use e.g. the battery fencer AKO Compact Power B 40



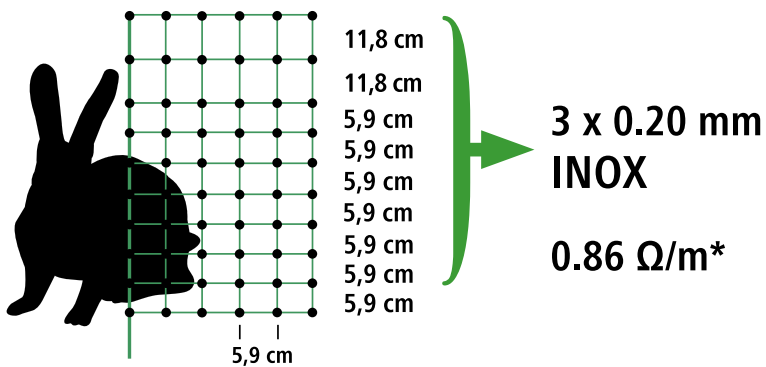

Extra small meshing 5,9 cm guarantees highest tending safety!

65 cm - 12 m / 25 m / 50 m



Fast and simple connection
with Litzclip®



ref. no.	description	colour			€
292209	Rabbit Netting 12 m, single prong, with 9 stable plastic posts	green	1	50	
292216	Rabbit Netting 25 m, single prong	green	1	50	
292221	Rabbit Netting 50 m, single prong	green	1	30	
292222	Rabbit Netting 50 m, double prong	green	1	30	
27249-5	Spare Top Insulator	-	1/10/500	-	
27250-5	Spare Stopper	-	1/10/500	-	
372005	Compact Power B 40	-	1	168	
44657	Earth / support rod to match Compact Power B 40	-	1	100	

ref. no.	description	colour		€
292210-5	Spare Post, single prong	black	1/50	
292211-5	Spare Post, double prong	black	1/50/200	

Sheep Netting



TitanNet

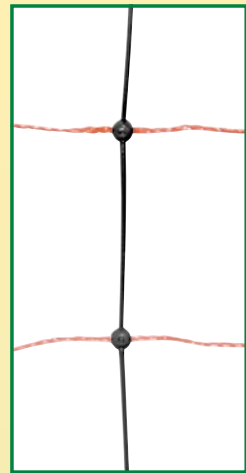

Enhanced stability and optimal terrain suitability provided by sturdy vertical strands 30 cm apart.

TitanNet

Sheep Netting with Vertical Struts

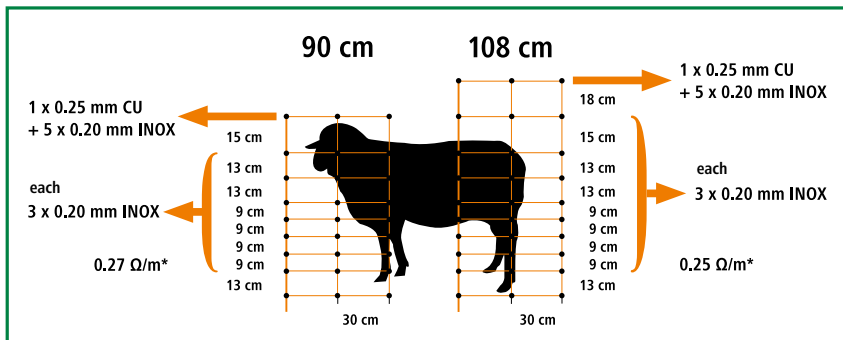

TitanNet sheep netting was developed particularly for uneven terrain. Instead of the soft stranded material, rigid plastic strands were used for the verticals. These are durably connected every 30 cm to the horizontal strands, thus providing compact stability even in hilly and uneven terrain.

- height 90 cm or 108 cm • length 50 m • 14 stable plastic posts • electrifiable horizontals through 3 x 0.20 mm stainless steel conductors per strand • increased conductivity thanks to the use of 5 Niro wires and a tin-plated copper wire in the topmost wire • strengthened, energized upper strand • welded knots • galvanised ground spike on plastic stake • head insulator and ground stopper make self-loosening of the wire virtually impossible • the plastic strands have a 3-year UV-resistance warranty



* based on the total conductor cross-section of all live wires in the mains network

Particularly suitable for application with several nets in a row. Optimal conduction to the furthest sheep netting through copper conductor in the top strand! 20 times higher conductivity compared to standard nets!

ref. no.	description	suitable spare post			€
27211	TitanNet, 90 cm, single prong	27276	1	30	
27212	TitanNet, 90 cm, double prong	27277	1	30	
27213	TitanNet, 108 cm, single prong	27278	1	30	
27214	TitanNet, 108 cm, double prong	27279	1	30	



Top Insulator

ref. no.	description	colour		€
27276	Spare Post, 90 cm, single prong	black	1/100	
27277	Spare Post, 90 cm, double prong	black	1/50	
27278	Spare Post, 108 cm, single prong	black	1/100	
27279	Spare Post, 108 cm, double prong	black	1/50	
27293	Sheep Netting Repair Set	orange	1/100	
27249-5	Spare Top Insulator	-	1/10/500	
27250-5	Spare Stopper	-	1/10/500	
27322	Floor Anchor Plastic	-	1/10/300	



Stopper

Sheep Netting





OviNet

- height 90 cm or 108 cm
- length 50 m
- 14 stable plastic posts
- electrifiable horizontals through 3 x 0.20 mm stainless steel conductors per strand
- increased conductivity thanks to the use of 5 Niro wires and a tin-plated copper wire in the topmost wire
- strengthened, energized upper strand
- welded knots
- plastic posts with galvanized spikes
- top insulator and stopper prevent the net from coming loose
- we offer a 3-year warranty against UV damage for all plastic wires

Particularly suitable for application with several nets in a row. Optimal conduction to the furthest sheep netting through copper conductor in the top strand! 20 times higher conductivity compared to standard nets!

OviNet orange

Electrifiable Sheep Netting for Universal Use

ref. no.	description	colour	suitable spare post			€
27251	OviNet, 90 cm, single prong	orange	27245	1	35	
27252	OviNet, 90 cm, double prong	orange	27246	1	35	
27253	OviNet, 108 cm, single prong	orange	27247	1	35	
27254	OviNet, 108 cm, double prong	orange	27248	1	35	

ref. no.	description	colour	MQ		€
27245	Spare Post, 90 cm, single prong	red	1	1/100	
27246	Spare Post, 90 cm, double prong	red	1	1/50	
27247	Spare Post, 108 cm, single prong	red	1	1/100	
27248	Spare Post, 108 cm, double prong	red	1	1/50	
27293	Sheep Netting Repair Set	orange	1	1/100	
27249-5	Spare Top Insulator	-	10	1/10/500	
27250-5	Spare Stopper	-	1	1/10/500	
27322	Floor Anchor Plastic	-	1	1/10/300	

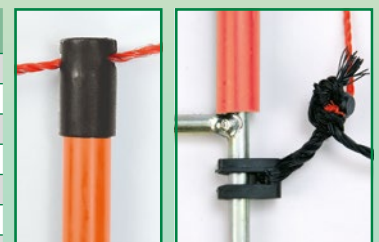

Top Insulator

Stopper

Sheep Netting

OviNet

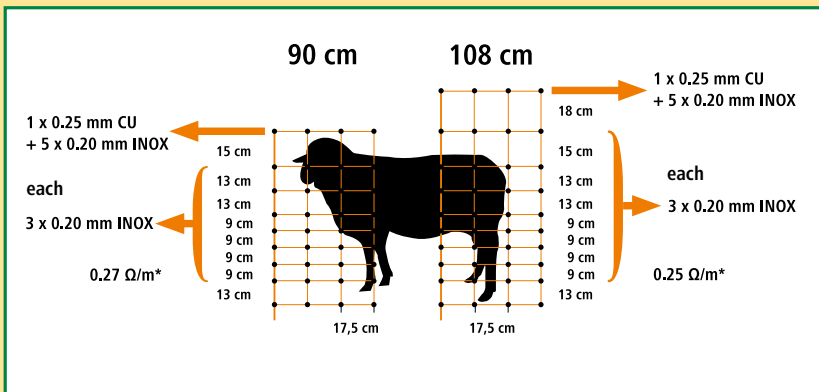

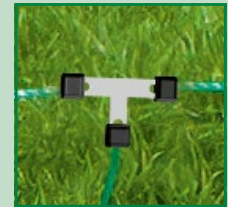

Fast and simple connection with Litzclip®



* based on the total conductor cross-section of all live wires in the mains network

OviNet green

Electrifiable Sheep Netting for Universal Use

ref. no.	description	colour	suitable spare post			€
27265	OviNet, 90 cm, single prong	green	27276	1	35	
27266	OviNet, 90 cm, double prong	green	27277	1	35	
27267	OviNet, 108 cm, single prong	green	27278	1	35	
27268	OviNet, 108 cm, double prong	green	27279	1	35	

ref. no.	description	colour	MQ		€
27276	Spare Post, 90 cm, single prong	black	1	1/100	
27277	Spare Post, 90 cm, double prong	black	1	1/50	
27278	Spare Post, 108 cm, single prong	black	1	1/100	
27279	Spare Post, 108 cm, double prong	black	1	1/50	
27294	Sheep Netting Repair Set	green	1	1/100	
27249-5	Spare Top Insulator	-	10	1/10/500	
27250-5	Spare Stopper	-	1	1/10/500	
27322	Floor Anchor Plastic	-	1	1/10/300	

Poultry Netting



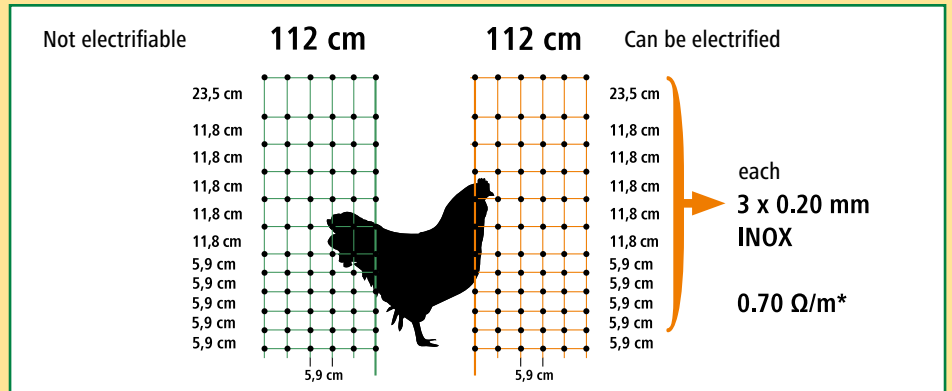

- for hens, geese, turkeys
- height: 112 cm
- welded knots
- strengthened top strand
- particularly small mesh width in the lower area of the net
- stable, easily visible plastic stakes
- also suitable for lambs



* based on the total conductor cross-section of all live wires in the netting

PoultryNet orange electrifiable



ref. no.	description	colour	suitable spare post	MQ			€
292203	Poultry Netting, 50 m, single prong	orange	292212-7	1	1	25	
292204	Poultry Netting, 50 m, double prong	orange	292213-7	1	1	25	

ref. no.	description	colour		€
292212-7	Spare Post, single prong	orange	1/50/1050	
292213-7	Spare Post, double prong	orange	1/50	

Poultry Netting



PoultryNet green electrifiable

ref. no.	description	colour	suitable spare post	MQ			€
292220	Poultry Netting, 50 m, double prong	green	292213-5	1	1	25	
292224	Poultry Netting, 15 m, double prong	green	292213-5	1	1	40	
292215	Poultry Netting, 25 m, single prong	green	292212-5	1	1	40	
292214	Poultry Netting, 25 m, double prong	green	292213-5	1	1	40	
27249-5	Spare Top Insulator	-		10	1/10/500	-	
27250-5	Spare Stopper	-		1	1/10/500	-	



ref. no.	description	colour		€
292212-5	Spare Post, single prong	black	1/50/1050	
292213-5	Spare Post, double prong	black	1/50	

Fast and simple connection
with Litzclip®



PoultryNet green

not electrifiable

ref. no.	description	colour	suitable spare post	MQ			€
292208	Poultry Netting 50 m, single prong	green	292212-5	1	1	20	
292218	Poultry Netting 50 m, double prong	green	292213-5	1	1	25	
292217	Poultry Netting 25 m, single prong	green	292212-5	1	1	40	
292219	Poultry Netting 25 m, double prong	green	292213-5	1	1	40	
27249-5	Spare Top Insulator	-		10	1/10/500	-	
27250-5	Spare Stopper	-		1	1/10/500	-	

ref. no.	description	colour		€
292212-5	Spare Post, single prong	black	1/50/1050	
292213-5	Spare Post, double prong	black	1/50	

WolfNet



New!

WolfNet

The new wolf deterrent netting

The wolf is back and you must keep it away from your herd. The newly developed AKO WolfNet, the electrified protection netting against wolves, is an effective solution for herd protection.

The proven vertical struts of the TitanNet series provides stability even on hilly and uneven ground. A jump-proof netting variant that is heightened by 30 cm via an integrated caution tape ensures a high level of pasture safety. The non-electrified ground strand prevents the wolf's natural behaviour for digging. The proven posts from our Sheep Netting line ensure fast and easy setup.

Product details:

- available in 2 different heights! 95 cm or 108 cm to top edge of wire + an additional 30 cm of caution tape that can also be integrated (not part of the scope of delivery)
- 15 integrated black plastic posts with double tip
- 6 x conducting TriCOND rows each 3 x 0.30 mm offer optimal conductivity
- non-electrified ground strand prevents digging
- improved footing and optimal terrain adaptation thanks to stable vertical struts every 30 cm
- extra large spacing to the ground (first conducting strands starting at 18 cm of height)

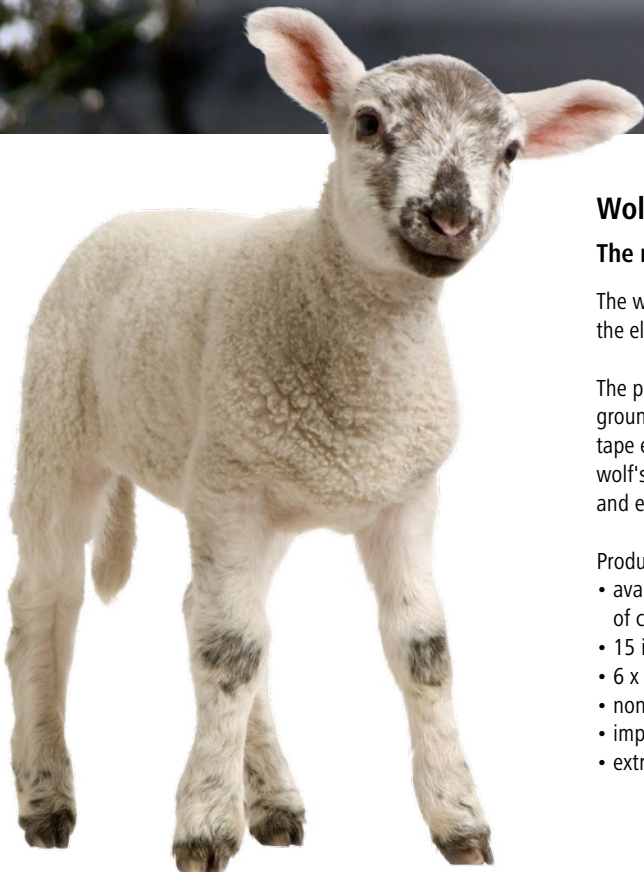

Wolf Deterrent

Following practical tests, the Federal Office for the Environment, Agriculture and Geology of the Free State of Saxony recommends electrified netting with a height of 90 cm as a safety measure against wolves!



Spare head insulator



Spare ground stopper



Caution tape: Early optical deterrent for wolves as an additional protection measure for your sheep!



125 cm incl. signalling band

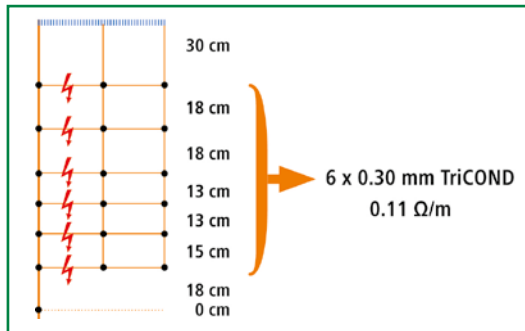

138 cm incl. signalling band

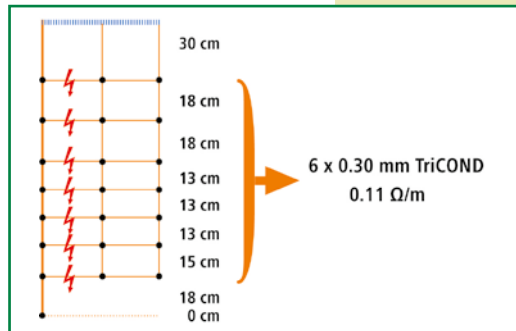

New!

ref. no.	description			€
27205	Netting height: 95 cm (125 cm with caution tape)	1	30	
27206	Netting height: 108 cm (138 cm with caution tape)	1	30	
27216	Caution tape for WildNet (250 m long, blue)	1	300	
27207	Spare Wolf Netting 95 cm black, double prong	1	-	
27208	Spare Wolf Netting 95 + 30 cm black, double prong	1	-	
27209	Spare Wolf Netting 108 + 30 cm black, double prong	1	-	
27249-5	Spare Top Insulator	1/10/500	-	
27250-5	Spare Stopper	1/10/500	-	



Wild Animal Deterrent Netting

WildNet



Patent pending!

WildNet

The straightforward solution for keeping wild animals at bay!

- length 50 m
- 3 x TriCOND rows, white/blue with 3 x 0.30 mm TriCOND wires each provide optimum conductivity (up to 10.000 m fence length)
- 12 x blue fibreglass posts
- post 75 cm above ground
- post 90 cm in total
- distance between posts approx. 4.5 m
- blue vertical struts, 60 cm apart
- 3 x conducting strands: bottom distance from ground 22 cm, center 41 cm, top 63 cm
- incl. accessories: jointing sleeves (item no. 27321), 3 x base anchors (item no. 27322) with black nylon cord for de-tensioning, repair sign and caution sign (item no. 446513)
- 40 mm blue caution tape is available as a separate accessory (250 m), item no. 27216



Expert tip: place the signal light at the end of your fence system. This means you can tell at a glance whether the minimum herding voltage of 2,500 V is flowing at the end of your fence and thus through your entire system.

Advantages WildNet:

- quicker to assemble and disassemble than conventional electric fences
- ground clearance (better for mowing and significantly fewer diversions, i.e. more power to the fence)
- blue 40 mm plastic caution tape (250 m, item no. 27216) can be added to improve visibility
- nets are easy to connect with each other. The connector is integrated into the net. Separate connectors are not required

TriCOND = 5 x higher conductivity than stainless steel conductors

each
3 x 0.30 mm
TriCOND
= max. 10.000 m
(Inox = 2.000 m)
0.18 Ω/m*

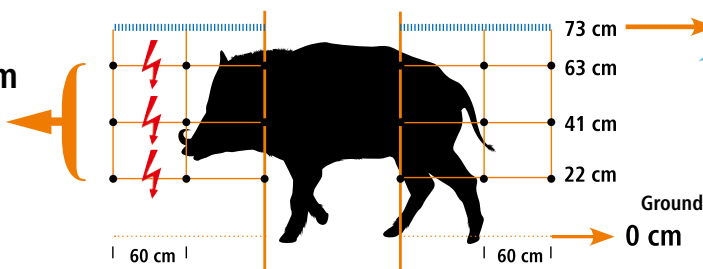



* (based on the total conductor cross-section of all live wires in the netting)



Caution tape 250 m
(not included in
scope of supply)

In windy areas, we recommend that you cut the caution tape into several pieces - approx. 50 - 100 cm - and secure each piece to the top of each post. The fluttering of the tape in the wind allows you to keep wild boars more effectively at bay.

ref. no.	description	length			€
27215	Wild animal deterrent netting	50 m	1	50	
27216	Caution tape for WildNet (250 m long, blue)	250 m	1	300	
27217	Spare post blue	90 cm	1/10	1,750	
44428	Spare insulator for 27217	-	1/25/1000	-	



44428

27217

A

Adaptor Cable 13, 24
Additional Eyelets
for Fibreglass Post 31
Allen key safety screw set 80
Angle Post 37
Angle Post Insulator 37
Anti-Theft-Box 11
Anti-Theft-Set 11

B

BASIC Fencing Ropes 47
BASIC Fencing Tapes 46
BASIC Polywires 47
Battery 23
Battery Charger 22
Battery energizer 5
Battery Energizers 12, 13
BIG Ring Insulator 59

C

Cable Insulator 28
Cavallo Tape Corner Insulator 29, 63
CLASSIC Fencing Ropes 45
CLASSIC Fencing Tapes 44
CLASSIC Polywires 45
Clip Insulator Easy Tape 62
Clip Insulator Allround 68
Clip Insulator Maxi Tape 61
Clip Tape Insulator 28
Combo Insulator 58
Compact Reel 57
Connecting cable 24
Connection Cable 24
Connection Kit 21
Connector Rope/Polywire 54
Corner and distance insulator
Profi 63
Corner Insulator 29, 63, 64
Corner Insulator Super 64
Corner Insulator
with metric thread 66
Corner Sleeve Insulator 51
Corner Solution
for Premium Horse Wire 51
Cross-profile recycling post 36
Cut-Out Switch 39

D

De-tensioning Set „Diagonal“ 51
De-tensioning Set „Horizontal“ 51
Digital Voltmeter 19
Distance Insulator 28
Door for electric fence nets 87
Double Loop Insulator 74
Drill 69
Dry Battery Alkaline 23
Duo Energizer
NA 1200 7
NA 2300 7

E

Earting Cable 21, 24
Easy Drill Ring Insulator EDX 58, 59
Easy Loop Plug Connector 51
Easy Tape Clip Insulator 62
Eco Gate System 73
EconomyLine Mono Wire 48
Eco Plastic Post 32
Electric fencer 5 - 17
Electric Fencer 6, 16
Electric Fence Units 9, 12, 13
Electric Gate 73
Electrics Kit for Fence Gates 80
E-line Gate Kit 73
E-Line Gate System 73
Energizer-to-tape connector 25

Euro Guard

A 1000 9
A 4000 9
A 10000 9
B 200 13
B 280 13
B 300 Multi 14
B 350 13
B digital 12
N 1400 6
N 2000 6
N 5500 6
N 8000 5
N 10000 D 5
N 15000 D 5
S 2600 8
S 4600 Digital 8

Euro Rope Insulator 60
Euro Tape Insulator 61

F

Farming forceps 69
Farming forceps Premium 69
Farm Patrol
A 130 14
A 150 17
A 350 17
B 160 15
B 300 15
N 1000 16
N 3000 16
N 6000 16
Fastening Ring for Round Posts 66
Fence checker 19
Fence-Checker 19
Fence Connecting Cable 24
Fence Connection Cable 24
Fence Controller 18
Fence/Earth Connection Cable 21
Fence Line Tester 19
Fence Panel
with gate 82
without gate 81
Fencing Wire Aluminium 48
Fibreglass Post 31
Fibre Glass Post 31
Flexigate Gate System 72

G

Gate 73
Gate Handle 75, 76, 77
Gate handle connector Litzclip® 75
Gate Handle Insulator for T-Post 30
Gate Handle Insulator Vario 74
Gate Handle Insulator Vario Profi 74
Gate Handle Insulator
with Metric Thread 66, 74
Gate Handle with spring 74
Gate Insulator Profi for Tapes 64
Gate Kit 74
Gate Lock 76
Geared Reel 3 : 1 57
Ground Connection Cable 24
Ground Rod 21
GSM-Alarm 18

H

High-Voltage Underground Cable 21
Hobbyset 20

I

In-Line Strainer, rotating 70
Insulators T-Post 30

K

Kramp Nail 71

L

Lightning Choke 39
Lightning Protection 39
Litzclip®
Gate handle connector 75
Repair kit 53
Rope Connector 52
Safety Link 52
Tape Connector 52
Wire Connector 53
Wire Cross-Connector 53
Wire T-Connector 53
Lockable Gate System 76

M

Mains Adapter 8
Mains Energizer 5, 6, 16
Mains Energizers 6
Metal Battery Box 11
Metal post 37, 38
Metal Protective Box 11
Metal T-Post 27
Modular hoardings 83
Mono Wire 48
Mounting Bracket for Reel 57
Multi post 37
Multi Post 57

N

Nail-on Insulator 68

O

Octo Wood 26
Offset Insulator 66, 67
Offset Pigtail Insulator 67
Offset Ring Insulator 67
Offset Rope Insulator 67
Offset Tape Insulator 67
OviNet Sheep Netting 90, 91

P

Pasture Gates
adjustable 78
Adjustable 79
Fixed 79
Permanent Wire Strainer 70
Pigtail Insulator 67
Pigtail Post 38
Pinlock Insulator 28
Pinlock Insulator 60, 71
Plastic Eyes 31
Plastic Post 31, 32, 34
Plastic Post Classic 32, 34
Plastic Post Eco 32
Plastic Post Titan 34
Plastic Post Titan Plus 32
Plastic Reel Super 56
Polywires
BASIC 47
CLASSIC 45
PROFI 43
STAR 41
Porcelain Corner Insulators 65, 71
Portable Fence Kit for Trekking 20
Post
Angle Post metal 37
fibre glass 31
metal 38
plastic 32
T-Post 27
Post Driver 69
Poultry Netting
green 93
orange 92
Power Gel Complete Set 23
Premium Combo Insulator 58
Premium Farming forceps 69

Premium Gate Handle 75
Premium Horse Wire 50
Premium Plus Gate Handle 75
Premium Tape Tensioner 61
Profi Clip Insulator 62
PROFI Fencing Rope 43
PROFI Fencing Tape 42
Profi Gate Insulator for Tapes 64
PROFI Polywires 43
Pulling Device for T-Post 30

R

Rabbit Netting 88
Rack 84, 85
Ram for T-post 30
Rechargeable Battery Energizers 8, 9
Rechargeable battery unit 9
Recycling Post 36
Reel
Big 56
Euro 56
Super Big 56
Reel Super Big 56
Repair kit Litzclip® 53
Ring Insulator
Big 58, 59
Easy Drill EDX 58, 59
Ring Insulator compact 59
Ring Insulators Big
with short support 58
Ring Insulator Super Big 58
Ring Insulator with metric thread 66
Rope and Wire Connector 55
Rope Connector 55
Rope Connector Litzclip® 52
Rope Connector Stainless Steel 55
Rope Connector with Lead 25
Rope corner solution for T-Post 29
Rope Insulator 60, 71
Euro 60
Pinlock 60, 71
Rope Insulator Euro Cord 60
Ropes
BASIC 47
CLASSIC 45
PROFI 43
STAR 41
Rope / Tape Connection 25
Rope-to-Rope Connector 25
Round Hay Rack 85
Round steel post 38

S

Safety Link Litzclip® 52
Screw bit for all ring Insulator 59
Screw Insulator Vario Plus 68
Screw Tight Insulator 68
Sheep Netting OviNet 90, 91
Sheep Netting TitanNet 89
Signal Light 18
Sledge Hammer 69
Slit Insulators 60
Slow Feeding Net 85
solar kit 10
Solar kit 10
Solar Panel 10
Spare Insulator 31
Special Steel Wire 49, 71
Spring Steel Post 38
Square hay rack 85
Square Hay Rack 84
Square rack for horses 84
STAR Fencing Ropes 41
STAR Fencing Tapes 40
STAR Polywires 41
Stirrup post 34
Strainer for Tapes 61
Strain Insulator 65
Strain Insulator Polyamide 65, 71
Stranded Wire galvanized 48
Supplementary Clip Insulator 68

Support Kit 27
Swing-Through Lock 80

T

Tape Connection Points 54
Tape Connector Galvanized 54
Tape Connector Litzclip® 52
Tape Connector Stainless Steel 54
Tape Corner Insulator Cavallo 63
Tape corner solution for T-Post 29
Tape Insulator 61, 62, 66
Euro Tape 61
Fencing Tape 61
Maxi Tape 61
Profi 63

Tapes

BASIC 46
CLASSIC 44
PROFI 42
STAR 40
Tape-to-tape connector 25
Tape-to-Tape Connector 25
Tension Spring 49, 70
Tensulator 70
TitanNet Sheep Netting 89
Titan PLUS 32
Titan-Post 32, 34
Top Insulator 28
Tournament Set 7 x 7 m 86
T-Post
Clip Tape Insulator 28
Distance Insulator 28
Gate Handle Insulator 30
Insulator Pinlock 28
Pulling Device 30
Ram 30
Ring Insulator 28
Rope Insulator 28
Tape Insulator for Gate Handle 30
Top Insulator 28
Universal Clamp Set 30
T-Post Tape Insulator
for Gate Handle 30
T-Post Universal Clamp Kit 30
Tube Insulator 65

U

Underground Cable 21

V

Vario Profi Gate Handle Insulator 74
Voltmeter Digital 19

W

Warning Sign 39
Warning sign -
Caution bull in field! 39
Wet Rechargeable Battery 22
Wild animal deterrent netting 96
Wire connecting clamp 55
Wire Connector 55
Wire Connector Gripple 55
Wire Connector Litzclip® 53
Wire Cross-Connector Litzclip® 53
Wire galvanized 49
Wire Pay-Out Spinner 49
Wire T-Connector Litzclip® 53
WolfNet 94
Wooden Mallet 69
Wood Post 26

Z

Zinc-Carbon Dry Battery 23
Zinc-Carbon Dry Battery round 23



We are constantly striving to improve our stock of products and keep them right up to date.
We reserve the right to make design changes.
The publication of this catalogue renders all previous catalogues and prices lists for these products invalid.
All prices provided are the manufacturer's recommended retail prices and are inclusive of VAT.
All information is subject to typing and printing errors.
All prices are subject to change.
Changes in colour and design may occur due to printing technology reasons.
Reprinting in whole or in part is due to prior authorisation.

Batteries are accessory items and are therefore not included in the equipment's scope of delivery.

You can significantly improve the tending safety of your paddock with the products listed.
Local influences and conditions can affect your fence system, which is why absolute tending safety cannot be guaranteed.
The vendor offers no warranty that the fence system is secure against break-outs; in fact, the safety system should be improved with the electric fence device and corresponding accessories.

Retail only via specialist dealers.
© 02/2016

Albert Kerbl GmbH
Felizenzell 9
84428 Buchbach • Germany
Tel.: +49/(0)8086/933 - 100
Fax: +49/(0)8086/933 - 500
E-Mail: info@kerbl.com
www.kerbl.com